



Fall Protection

USER INSTRUCTION MANUAL
 EZ-Stop™ Energy Absorbing Lanyards
 EZ-Stop™ Force2™ Energy Absorbing Lanyards
 EZ-Stop™ WrapBax™2 Lanyards
 EZ-Stop™ Modular Lanyards
 Shockwave™2 Force2™ Energy Absorbing Lanyards
 Model numbers: See Page 12

DBI-SALA
ENERGY ABSORBING LANYARDS

Please read this User Manual carefully before installing and using this product.

LANYARDS WITH INTEGRAL ENERGY ABSORBERS AND ENERGY ABSORBER COMPONENTS USED IN PERSONAL FALL ARREST SYSTEMS (ANSI Z359.13)

This manual is intended to meet the Manufacturer's Instructions as required by ANSI Z359.13, and should be used as part of an employee training program as required by OSHA.

DANGER: This product is part of a personal fall arrest, climbing, or rescue system. Working at height creates inherent and unavoidable risks which can result in serious injury or death. The user must follow the manufacturer's instructions for each component of the system. These instructions must be provided to the user of this equipment. The user must read and understand these instructions before using this equipment. Manufacturer's instructions must be followed for proper use and maintenance of this equipment. Alterations or misuse of this product or failure to follow instructions may result in serious injury or death.

Figure 1 - EZ-Stop™ Energy Absorbing Lanyards

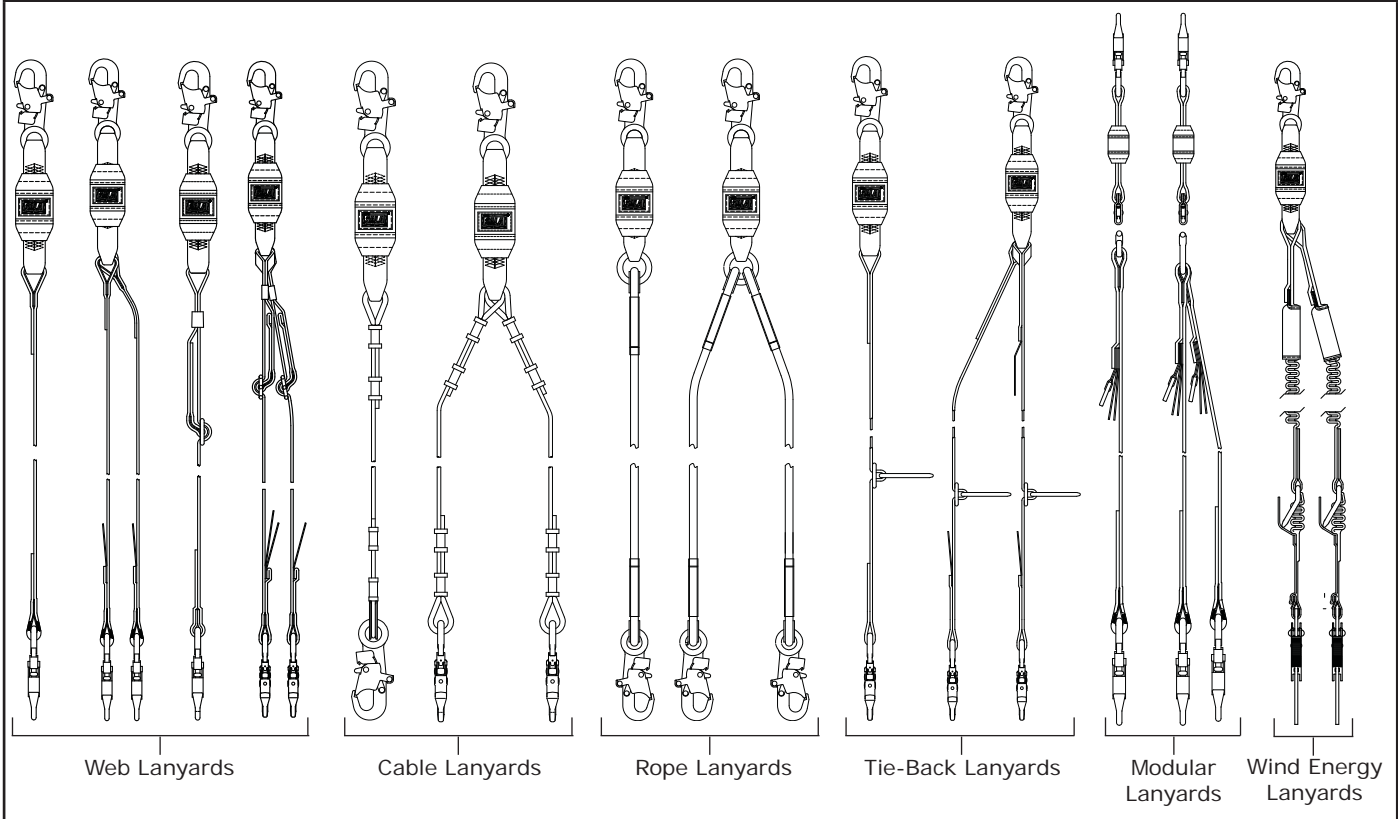

DESCRIPTION:



Figure 1 identifies currently available DBI-Sala EZ-Stop Energy Absorbing Lanyard types.

IMPORTANT: If you have questions on the use, care, or suitability of this equipment for your application, contact Capital Safety.

IMPORTANT: Before using this equipment, record the product identification information from the ID label in the "Inspection and Maintenance Log" in this instruction document.

1.0 APPLICATIONS

- 1.1 **PURPOSE:** Energy absorbing lanyards are to be used as components in Personal Fall Protection Systems designed to safely arrest a fall. See Figure 1 for the energy absorbing lanyard types covered by this instruction. Energy absorbing lanyards are used in the following applications:

	<p>Fall Arrest: Fall arrest systems safely stop the user in a free fall from a height. The user can then self-rescue or be rescued. Personal fall arrest systems typically include a full body harness and an energy absorbing lanyard. Maximum arresting force must not exceed 1,800 lbs (8 kN).</p>
	<p>Restraint: Restraint systems prevent the user from reaching a fall hazard (example: leading edge roof work).</p>
	<p>Rescue: The energy absorbing lanyard is used as a component of a back-up fall protection system during rescue or as part of the primary rescue system.</p>

1.2 LIMITATIONS AND REQUIREMENTS:

WARNING: Always consider the following application limitations and requirements before using this equipment.

- A. CAPACITY:** The EZ-Stop Energy Absorbing Lanyard is designed for use by persons with a combined weight (clothing, tools, etc.) of no more than 310 lbs (141 kg)¹. Make sure all of the components in your system are rated to a capacity appropriate to your application.
- B. FREE FALL:** Personal fall arrest systems incorporating this equipment must be rigged to limit the free fall to 6 feet (1.8 m) or less when using EZ-Stop energy absorbing lanyard models, or 12 feet (3.7 m) or less when using EZ-Stop Force2 and EZ-Stop Leading Edge energy absorbing lanyard models.
- C. FALL CLEARANCE:** There must be sufficient clearance below the user to arrest a fall before the user strikes the ground or other obstruction. The clearance required depends on several factors:
- Deployment distance
 - Energy absorbing lanyard length
 - Movement of harness attachment element
 - Free fall distance
 - Elevation of anchorage
 - Worker height
- Figure 2 illustrates fall clearance calculation for an energy absorbing lanyard.
Figure 4 indicates the deployment distance of the personal energy absorber according to the user weight and free fall distance.
- D. SWING FALLS:** Swing falls occur when the anchorage point is not directly above the point where a fall occurs (see Figure 3). Minimize swing falls by working as close to and directly below the anchorage point as possible. Do not permit a swing fall if injury could occur.

WARNING: The force of striking an object in a swing fall may cause serious injury or death.

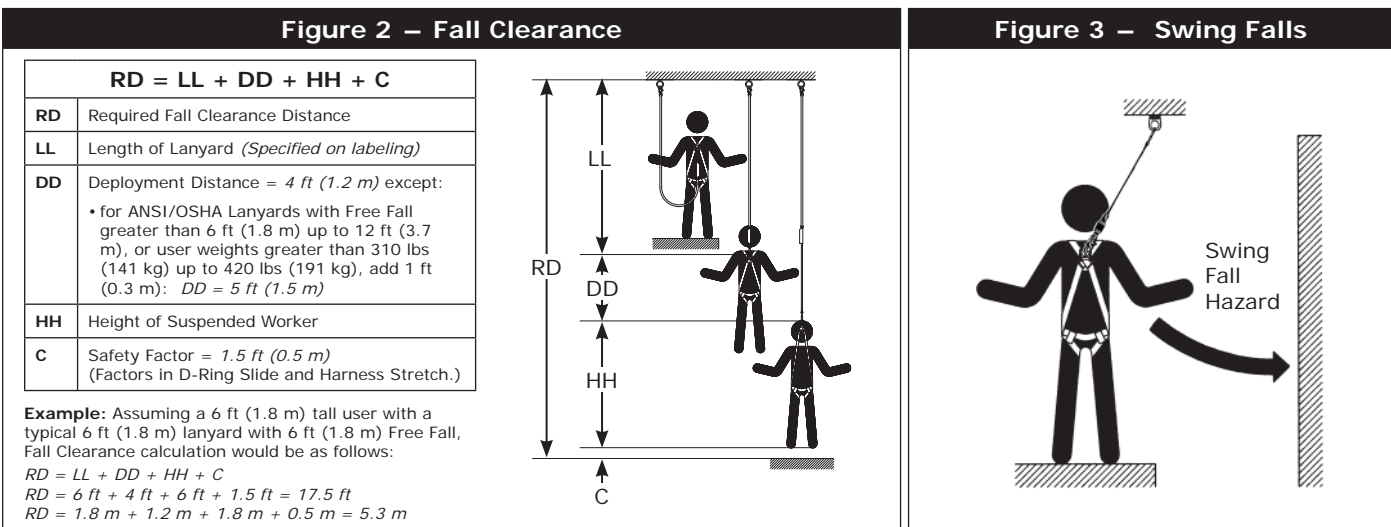

- E. ENVIRONMENTAL HAZARDS:** Use of this equipment in areas with environmental hazards may require additional precautions to prevent injury to the user or damage to the equipment. Hazards may include, but are not limited to; heat, chemicals, corrosive environments, high voltage power lines, gases, moving machinery, and sharp edges.
- F. LANYARDS FOR HIGH TEMPERATURE ENVIRONMENTS:** Lanyards with Kevlar webbing are designed for use in high temperature environments, with limitations: Kevlar webbing begins to char at 800° to 900° Fahrenheit. Kevlar webbing can withstand limited contact exposure to temperatures up to 1,000° F. Polyester webbing loses strength at 300° to 400° F. PVC coating on hardware has a melting point of approximately 350° F.

¹ **Capacity:** Most Capital Safety lanyards are factory tested to a maximum capacity of 310 lbs (141 kg). Force2 Lanyards are factory tested to a maximum capacity of 420 lbs (191 kg).

- G. **TRAINING:** It is the responsibility of the user and the purchaser of this equipment to assure that they are familiar with these instructions, trained in the correct care and use of, and are aware of the operating characteristics, application limits, and the consequences of improper use of this equipment.
- H. **LEADING EDGE:** EZ-Stop Leading Edge Energy Absorbing Lanyards have been successfully tested for horizontal use and for falls over a steel edge without burrs (See Leading Edge models listed in Table 2). As a result, EZ-Stop Leading Edge Energy Absorbing Lanyards may be used in situations where a fall may occur over similar edges such as those found on steel shapes or metal sheeting. Avoid working where the lifeline will continuously or repeatedly abrade against sharp or abrasive edges. Eliminate such contact or protect edges using a heavy pad or other means.
- I. **ARC FLASH:** Arc Flash lanyards listed in Table 2 meet the test requirements of the ASTM F887-12 standard and are designed for use in environments where an arc flash (electrical explosion) could occur.

- 1.3 **APPLICABLE STANDARDS:** Refer to national standards including the ANSI Z359 family of standards on fall protection, ANSI A10.32 and applicable local, state, and federal (OSHA) requirements governing occupational safety for more information on Energy Absorbing Lanyards, Energy Absorbers and associated components. EZ-Stop Arc Flash models listed in Table 2 meet the requirements of ASTM F887-13 for Type A Shock Absorbing Lanyards.
- 1.4 **RESCUE PLAN:** When using this equipment, the employer must have a rescue plan and the means at hand to implement the rescue, as well as communicate that plan to users, authorized persons, and rescuers.
- 1.5 **INSPECTION BEFORE USE:** The energy absorbing lanyard must be inspected according to procedures in *Section 4* of this instruction manual.

Figure 4 – Deployment Distance vs. Free Fall Distance, EZ-Stop™ Personal Energy Absorbers

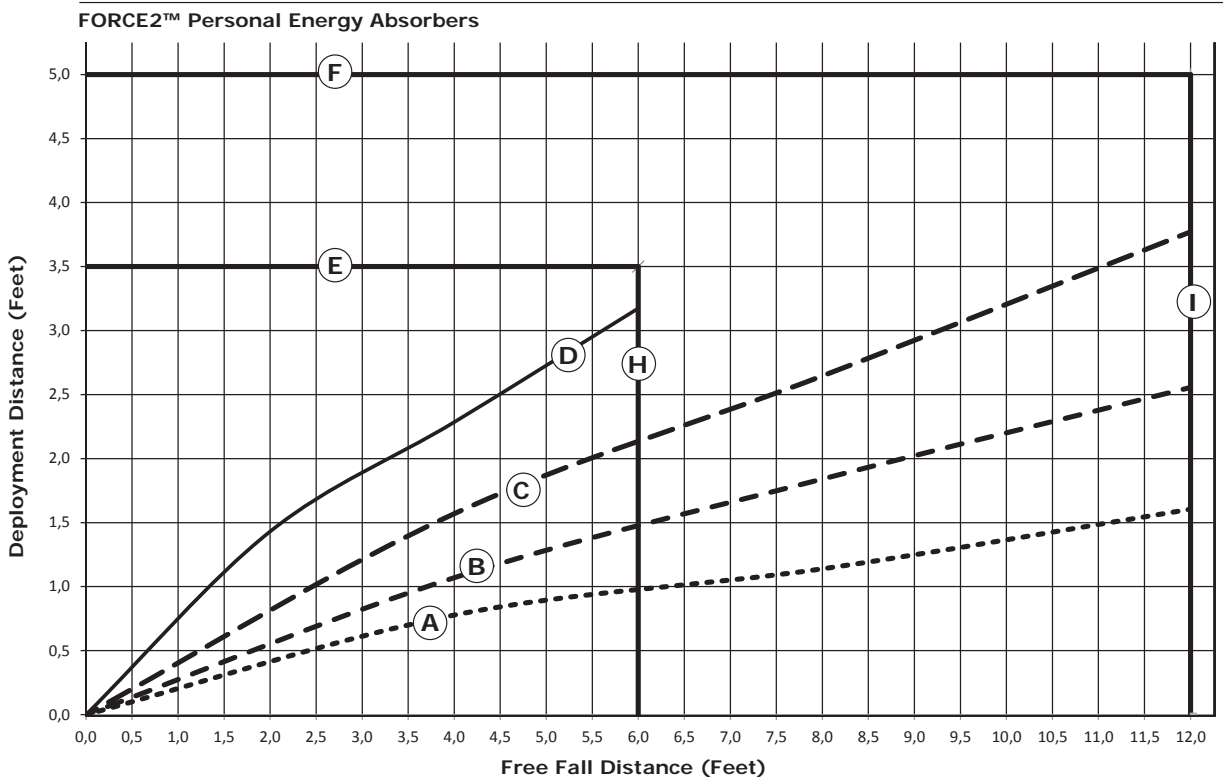
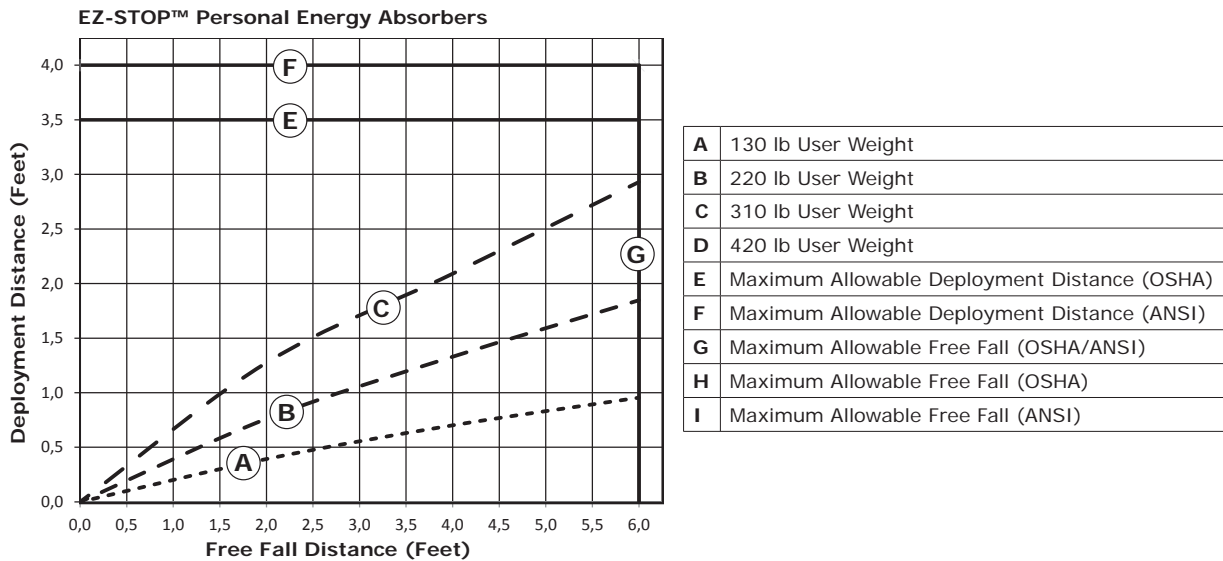

IMPORTANT: All distances shown in Figure 4 are based on results obtained during dynamic performance testing of EZ-Stop energy absorbing lanyards in the ambient dry condition in accordance with ANSI Z359.13. Actual distances may vary depending on environmental conditions, swing falls, etc. The maximum elongation of energy absorber value specified on the product labeling should be used when performing fall clearance calculations.

2.0 SYSTEM REQUIREMENTS

2.1 COMPATIBILITY OF COMPONENTS: Capital Safety equipment is designed for use with Capital Safety approved components and subsystems only. Substitutions or replacements made with non-approved components or subsystems may jeopardize compatibility of equipment and may effect the safety and reliability of the complete system.

2.2 COMPATIBILITY OF CONNECTORS:

IMPORTANT: Use only connectors that are suitable to each application and are compatible with connecting elements.

- Connectors must be compatible with the anchorage or other system components.
- Connectors must be compatible in size, shape, and strength.
- Non-compatible connectors may unintentionally disengage (see Figure 5).

Connectors are considered to be compatible with connecting elements when they have been designed to work together in such a way that their sizes and shapes do not cause their gate mechanisms to inadvertently open regardless of how they become oriented. Contact Capital Safety if you have any questions about compatibility.

Self-locking snap hooks and carabiners are required by ANSI Z359.13 and OSHA. Connectors (hooks, carabiners, and D-Rings) must be capable of supporting at least 5,000 lbs. (22.2 kN). Per ANSI Z359.12, connector gates must be able to withstand a load of 3,600 lbs (16 kN).

Figure 5 – Unintentional Disengagement

If the connecting element to which a snap hook (shown) or carabiner attaches is undersized or irregular in shape, a situation could occur where the connecting element applies a force to the gate of the snap hook or carabiner. This force may cause the gate (of either a self-locking or a non-locking snap hook) to open, allowing the snap hook or carabiner to disengage from the connecting point.

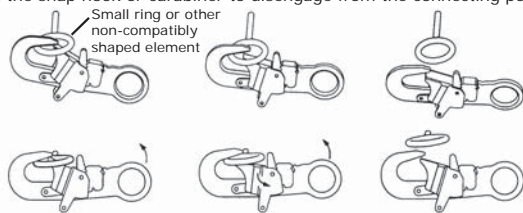

Force is applied to the Snap Hook.

The Gate presses against the Connecting Ring.

The Gate opens allowing the Snap Hook to slip off.

Figure 6 – Inappropriate Connections

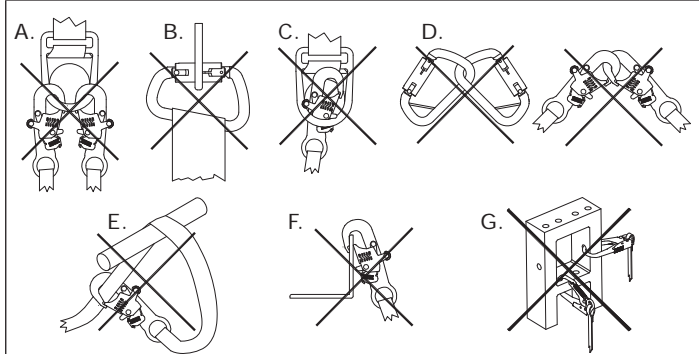

2.3 MAKING CONNECTIONS: Capital Safety connectors (snap hooks and carabiners) are designed to be used only as specified in each product's user's instructions. See Figure 6 for inappropriate connections.

Capital Safety snap hooks and carabiners should not be connected:

- To a D-Ring to which another connector is attached.
- In a manner that would result in a load on the gate.

WARNING: Large throat snap hooks should not be connected to standard size D-Rings or similar objects which will result in a load on the gate if the hook or D-Ring twists or rotates, unless the snap hook complies with ANSI Z359.12 and is equipped with a 3,600 lb (16 kN) gate. Check the marking on your snap hook to verify that it is appropriate for your application.

- In a false engagement, where features that protrude from the snap hook or carabiner catch on the anchor, and without visual confirmation seems to be fully engaged to the anchor point.
- To each other.
- Directly to webbing or rope lanyard or tie-back (unless the manufacturer's instructions for both the lanyard and connector specifically allows such a connection).
- To any object which is shaped or dimensioned such that the snap hook or carabiner will not close and lock, or that roll-out could occur.
- In a manner that does not allow the connector to align properly while under load (unless using Capital Safety snap hooks that have been specifically designed and tested for these applications). Contact Capital safety for more information.

CAUTION: Ensure all connectors are fully closed and locked.

2.4 EZ-STOP MODULAR ENERGY ABSORBING LANYARD MODELS: Refer to Operation and Use, Section 3.3 for instructions on the assembly of the energy absorbing and lanyard components of the EZ-Stop Modular Energy Absorbing Lanyard system.

- 2.5 WEB LOOP CONNECTIONS:** Some lanyards are designed to choke onto a web loop to provide a compatible connection. To choke the lanyard on a web loop:

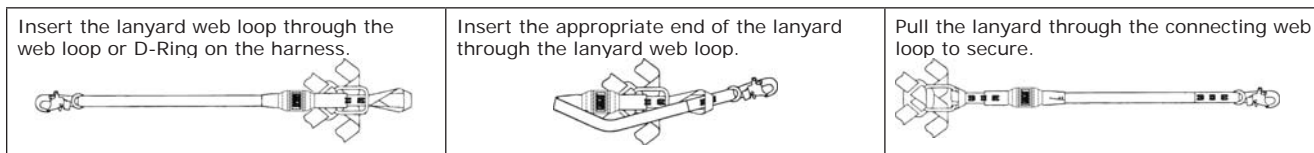

- 2.6 ANCHORAGE STRENGTH:** Anchorages selected for use with the energy absorbing lanyards must have a strength capable of sustaining the static load requirements of the intended fall protection application:

- A. Fall Arrest:** Anchorages selected for personal fall arrest systems (PFAS) shall have a strength capable of sustaining static loads applied in the directions permitted by the system of at least:
1. Two times the average² arresting force for certified anchorages³, or
 2. 5,000 pounds (22.2 kN) for non-certified anchorages.

When more than one fall arrest system is attached to an anchorage, the strengths set forth in (1) and (2) above shall be multiplied by the number of systems attached to the anchorage.

WARNING: Anchorages must be rigid. Large deformations of the anchorage will affect system performance, and may increase the required fall clearance below the system, which could result in serious injury or death.

From OSHA 1926.500 and 1910.66: Anchorages used for attachment of PFAS must be independent of any anchorage being used to support or suspend platforms and must be capable of supporting at least 5,000 lbs. (22.2 kN) per each attached user. Or, be designed, installed, and used as part of a complete PFAS which maintains a safety factor of at least two, and is supervised by a qualified person.

- B. Work Positioning:** Anchorages selected for work positioning systems shall have a strength capable of sustaining static loads applied in the directions permitted by the system of at least:
3. Two times the foreseeable force for certified anchorages, or
 4. 3,000 pounds (13.3 kN) for non-certified anchorages.

When more than one work positioning system is attached to an anchorage, the strengths set forth in (3) and (4) above shall be multiplied by the number of systems attached to the anchorage.

- C. Restraint:** Anchorages selected for restraint and travel restraint systems shall have a strength capable of sustaining static loads applied in the directions permitted by the system of at least:
5. Two times the foreseeable force for certified anchorages, or
 6. 1,000 pounds (4.5 kN) for non-certified anchorages.

When more than one restraint or travel restraint system is attached to an anchorage, the strengths set forth in (5) and (6) above shall be multiplied by the number of systems attached to the anchorage.

- D. Rescue:** Anchorages selected for rescue systems shall have a strength capable of sustaining static loads applied in the directions permitted by the system of at least:
7. Five times the foreseeable force for certified anchorages, or
 8. 3,000 pounds (13.3 kN) for non-certified anchorages.

When more than one rescue system is attached to an anchorage, the strengths set forth in (7) and (8) above shall be multiplied by the number of systems attached to the anchorage.

- 2 Average Arresting Force:** ANSI Z359.13 requires 6 ft energy absorbers to have an average arresting force no greater than 900 lbs. (4 kN) and a maximum deployment distance of 48 in. (1.2 m) without exceeding 1,800 lbs. (8 kN) maximum arresting force. 12 ft energy absorbers are required to have an average arresting force no greater than 1,350 lbs. (6 kN) and a maximum deployment distance of 60 in. (1.5 m) without exceeding 1,800 lbs. (8 kN) maximum arresting force.
- 3 Certified Anchorage:** An anchorage for fall arrest, positioning, or rescue systems that a qualified person certifies to be capable of supporting the potential fall forces that could be encountered during a fall or that meet the criteria for certified anchorage prescribed by the associated standard(s).

3.0 OPERATION AND USE

WARNING: Do not alter or intentionally misuse this equipment. Consult Capital Safety when using this equipment in combination with components or subsystems other than those described in this manual. Some subsystem and component combinations may interfere with the operation of this equipment. Use caution when using this equipment around moving machinery, electrical hazards, chemical hazards, sharp edges, or overhead materials that may fall onto the lanyard. Do not loop the lanyard around small structural members. Failure to heed this warning may result in equipment malfunction, serious injury, or death.

WARNING: Consult your doctor if there is reason to doubt your fitness to safely absorb the shock from a fall arrest. Age and fitness seriously affect a worker's ability to withstand falls. Pregnant women or minors must not use any DBI SALA full body harness.

- 3.1 **BEFORE EACH USE** of this equipment, inspect it according to "Inspection Checklist" (Table 1).
- 3.2 **PLAN** your system before use. Consider all factors that will affect your safety during use of this equipment. The following list gives important points to consider when planning your system:
- A. **ANCHORAGE:** Select an anchorage that meets the requirements specified in "Limitations and Requirements".
 - B. **SHARP EDGES:** Avoid working where system components may be in contact with, or abrade against, unprotected sharp edges.
 - C. **AFTER A FALL:** Components which have been subjected to the forces of arresting a fall must be removed from service and destroyed. See the "Inspection Checklist" (Table 1).
 - D. **RESCUE:** The employer must have a rescue plan when using this equipment. The employer must have the ability to perform a rescue quickly and safely.
- 3.3 **EZ-STOP MODULAR ENERGY ABSORBING LANYARD COMPONENTS ASSEMBLY:** EZ-Stop Modular Energy Absorbing Lanyard system components must be properly assembled. The system consists of an energy absorber (A) and a single or twin leg lanyard (B) (See Figure 8).

Figure 8 – Modular EZ-Stop Energy Absorbing Lanyard Components

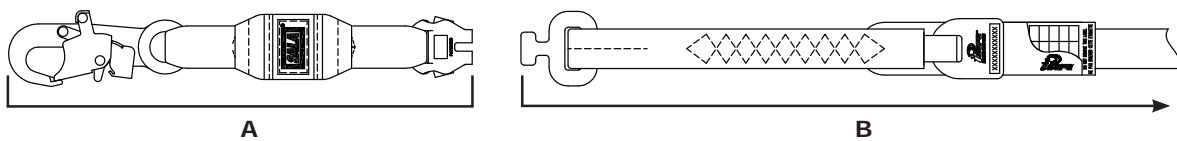

TO ASSEMBLE EZ-STOP MODULAR LANYARD COMPONENTS:

- Step 1:** Figure 9: Orient the energy absorber female connector and the lanyard male connector as shown.
- Step 2:** Figure 10: Press the female connector locks (C) on each side of the connector to unlock the device. Insert the male connector and slide to the bottom of the female connector. Release both locks to capture the male connector. The female connector locks must return to their fully extended position.
- Step 3:** Figure 11: Pull the energy absorber and lanyard in opposite directions to fully seat the male connector. The male connector must be securely locked in the position shown.

Figure 9 – Connector Orientation



Figure 10 – Press Female Connector Locks, Insert Male Connector

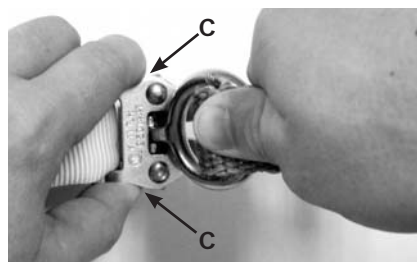
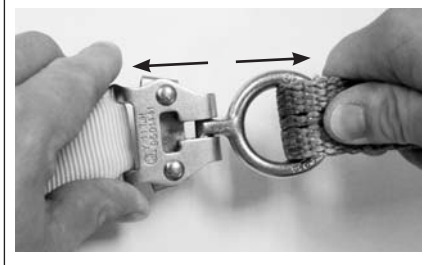

Figure 11 – Fully Connected



WARNING: Do not use the modular lanyard assembly if the locks do not return to the fully extended position after following Steps 1, 2 and 3 in Section 3.3.

An example of a failed connection is shown in Figure 12. The lanyard male connector is not fully inserted and locked within the energy absorber female connector. This is an unsafe condition and the modular lanyard components must not be used.

Refer to Section 4.0 Inspection in this instruction for procedures to determine unsafe or defective component conditions.

Figure 12 – Failed Connection



TO DISASSEMBLE EZ-STOP LANYARD MODULAR COMPONENTS:

- Step 1:** Figure 13: Press the female connector locks (C) on each side of the connector to unlock the device.
- Step 2:** Figure 14: While pressing the female connector locks, push the energy absorber and lanyard connectors toward each other.
- Step 3:** Figure 15: Pull the male connector out of the female connector to separate the components.

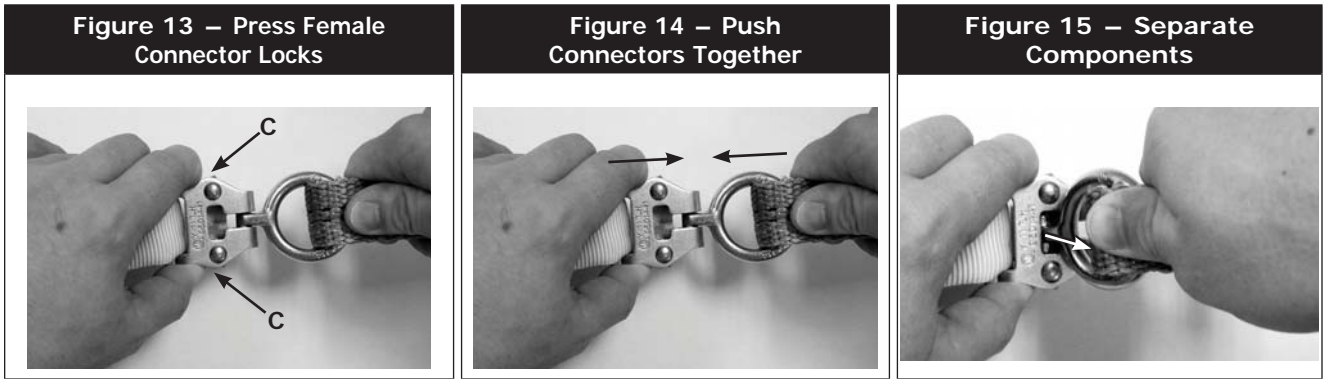

3.4 CONNECTING TO BODY SUPPORT AND ANCHORAGE OR ANCHORAGE CONNECTOR: See Figure 16. Energy absorbing lanyards should be connected to the body support first and then connected to the rest of the system. Always connect the energy absorber end of the lanyard to the D-Ring on the back between the shoulders (dorsal D-Ring) on a full body harness. DBI-SALA does not recommend using a body belt for fall arrest applications. If using a body belt, connect the energy absorbing end of the lanyard to the D-Ring and position the belt so the D-Ring is located on the back side of the body.

Connect the lanyard end to the anchorage or anchorage connector. Some anchorage connector devices may be supplied with a permanently attached energy absorber. Use of an additional energy absorber or energy absorbing lanyard with this lanyard system is not recommended.

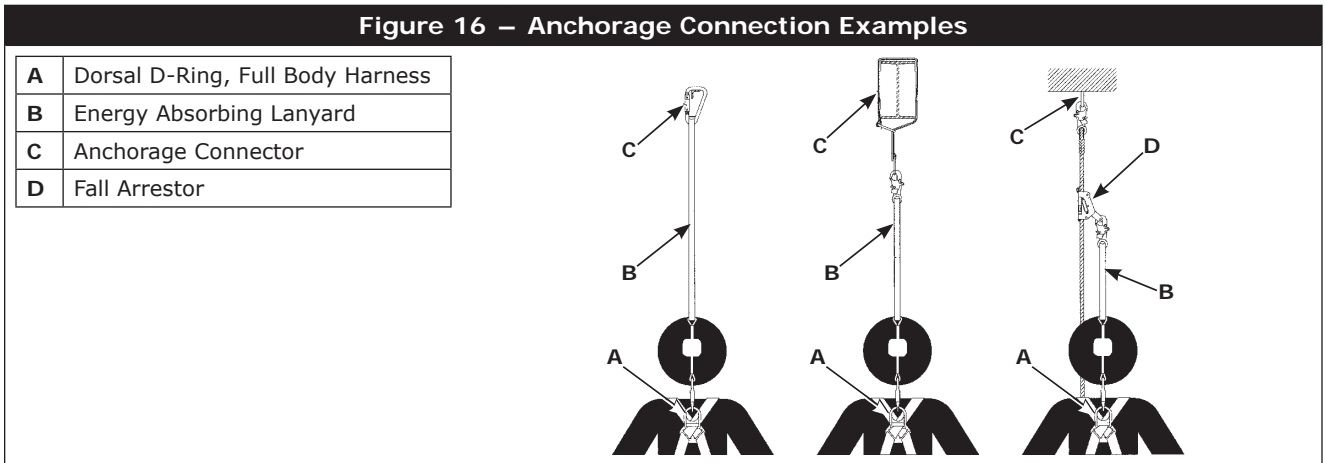

- 3.5 A. 100% TIE-OFF LANYARD CONSIDERATIONS:** Commonly known as 100% tie-off, “Y” type, twin leg, or double lanyards; these energy absorbing lanyards can be used to provide continuous fall protection while ascending, descending, or moving laterally. With one lanyard leg attached, the worker can move to a new location, attach unused lanyard leg, and disconnect attached leg. This procedure is repeated until a new location is reached. Other practices that must be followed in order to use a 100% tie-off type lanyard safely include:
1. The energy absorber portion of the lanyard must be connected to the dorsal D-Ring only. Use only the snap hook (or other connector provided) to attach the energy absorber portion directly to the harness dorsal D-Ring. See Figures 17 and 18.
 2. Do not connect the energy absorber to the anchorage. See Figure 19.

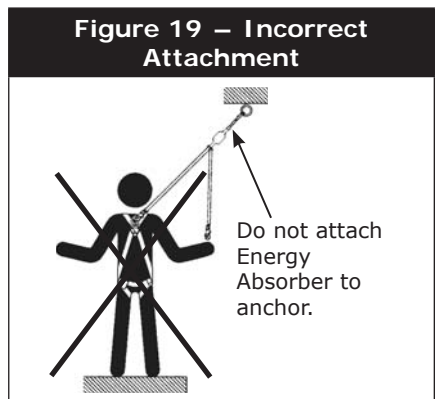
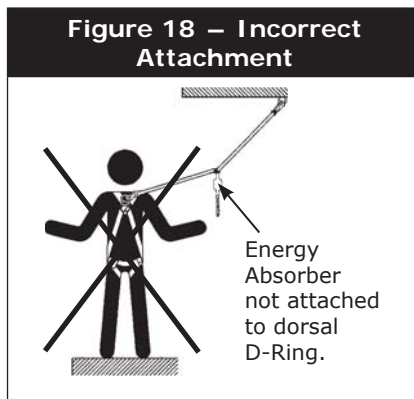
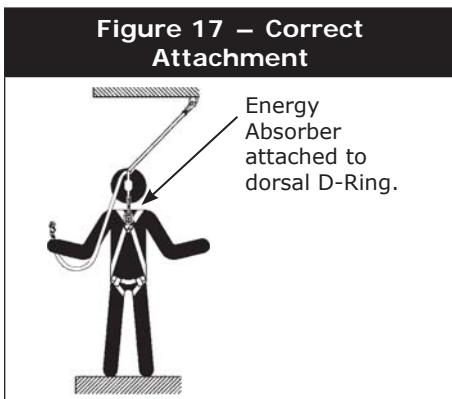

3. Do not attach the unused leg of the lanyard back to the harness at any location unless a specially designed lanyard retainer is provided for this purpose. See Figure 20.
4. Connection of both lanyard legs to separate anchorage points is acceptable. See Figure 21.
5. When leapfrogging from one anchorage point to the next (such as traversing a horizontal or vertical structure) do not connect to anchorage points that are further apart than the lanyard length (as marked on the lanyard label). See Figure 22.

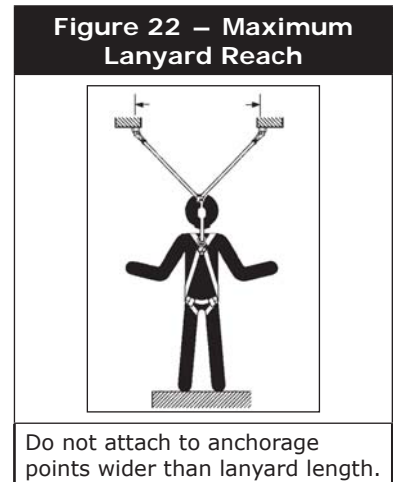
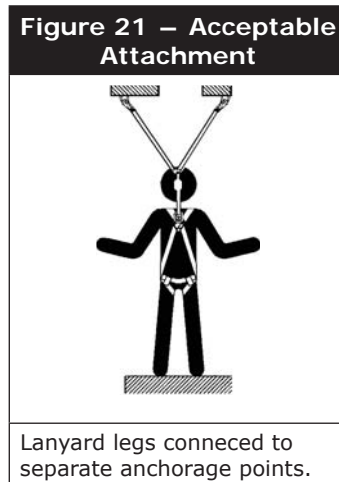
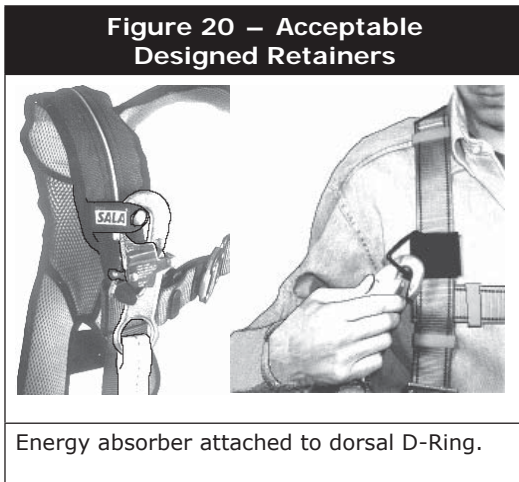

6. Never connect more than one person to a “Y” type lanyard at a time.
7. Do not allow any lanyard to pass under arms or legs during use.

Attaching a Tie-Back Lanyard: See Figure 23. Place the tie-back lanyard over the anchoring structure. Ensure the lanyard is not twisted. Adjust the floating D-Ring so it hangs below the anchoring structure. Attach the lanyard end hook to the floating D-Ring.

Ensure the lanyard is cinched tight around the anchorage during use.

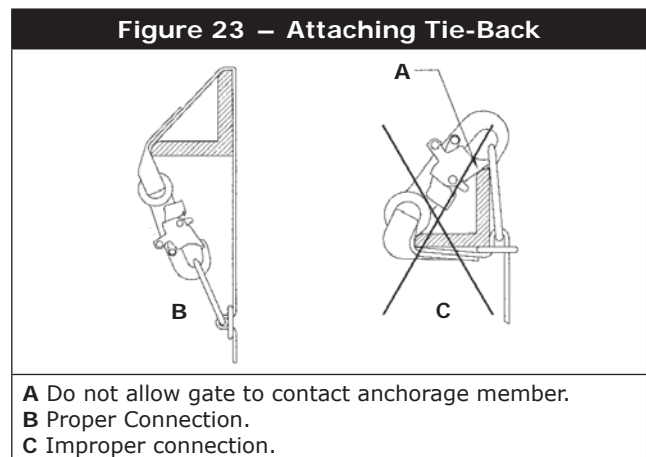

Attaching a WrapBax Lanyard: See Figure 24. Snap hooks and WrapBax hooks operate in the same manner. Grip the hook handle in one hand. With your index finger, depress the locking mechanism in. With your thumb, pull back the gate latch. As the gate latch is pulled back, the gate will open. Release your grip and the gate will close.

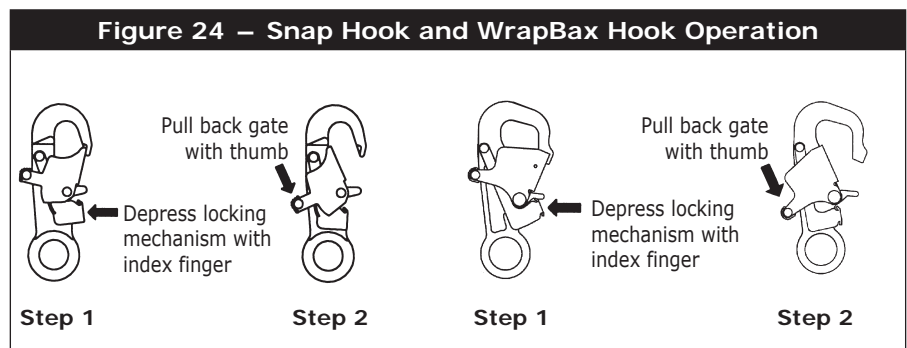

See Figure 25. Wrap the WrapBax lanyard around an appropriate anchor (see section 2.6), then open the gate of the WrapBax hook and pass the lanyard through the hook. The lanyard may make more than one wrap around the anchor, but the lanyard may only be passed through the WrapBax hook once. Make sure the lanyard is captured and the gate closes completely.

WARNING: Only the WrapBax hook may be used to snap back directly onto the WrapBax lanyard.

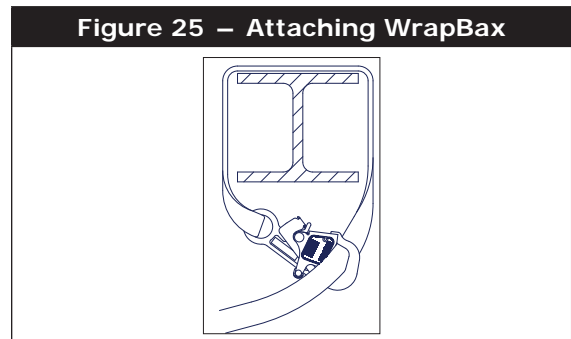

B. CONNECTING TO THE BODY SUPPORT: Connect the energy absorbing lanyard or energy absorber to the D-Ring on the back between the shoulders (dorsal D-Ring) on a full body harness. Connect so the energy absorber portion of the lanyard is on the body support side. DBI-SALA does not recommend using a body belt for fall arrest applications. If using a body belt, connect the energy absorbing lanyard or energy absorber to the D-Ring and position the belt so the D-Ring is located on the back side of the body.

C. ATTACHING A LANYARD WITH WEB LOOPS: See Section 2.5.

D. CONNECTING TO A ROPE GRAB (FALL ARRESTOR): It is recommended the lanyard end (vs. the energy absorber end) be attached to the rope grab. This recommendation is made to reduce possible interference with the operation of the rope grab by the energy absorber "pack." Attaching a component style energy absorber to a rope grab is not recommended, with the exception of a "direct-coupling" between a rope grab and a harness. Some rope grabs may be supplied with a permanently attached energy absorbing lanyard. For these cases, use of an additional energy absorber connected between the rope grab and the body support is not recommended.

In some cases it may be permissible to couple an energy absorber component between the anchorage (or anchorage connector) and the rope grab lifeline. In all cases, ensure the length of the energy absorber or energy absorbing lanyard does not exceed the rope grab manufacturer's recommended maximum connection length (3 feet [.9 m] maximum per ANSI Z359.1). Consult the manufacturer's instructions provided with the Rope Grab for further details.

E. CONNECTING TO SELF RETRACTING LIFELINE: DBI-SALA does not recommend connecting an energy absorbing lanyard or energy absorber component to a self retracting lifeline. Special applications do exist where it may be permissible. Contact DBI-SALA if considering connecting an energy absorbing lanyard to a self retracting lifeline.

3.6 AFTER USE, return the lanyard for cleaning or storage as described in section 5.0.

4.0 INSPECTION

4.1 i-Safe™ RFID TAG: Some lanyards include an i-Safe Radio Frequency Identification (RFID) tag (Figure 26). The RFID tag can be used in conjunction with the i-Safe handheld reading device to simplify inspection and inventory control and provide records for your fall protection equipment.

If you are a first-time user, contact a Capital Safety Customer Service representative (see back cover); or if you have already registered, go to isafe.capitalsafety.com. Follow the instructions provided with your i-Safe handheld reader or software to transfer your data to your database.

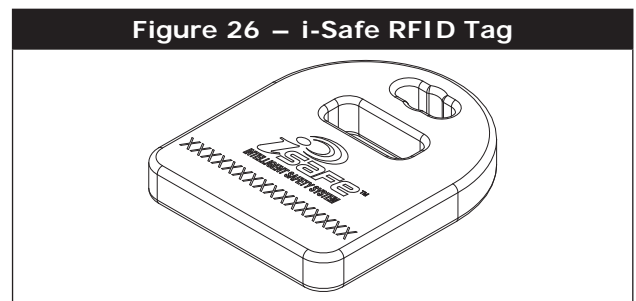

IMPORTANT: The i-Safe Identification Number on the RFID Tag is for purposes of electronic record keeping with the i-Safe system. Where the Serial Number is printed on the product's ID Label (see "Labeling"), the i-Safe Identification Number and Serial Number may be different numbers.

4.2 INSPECTION FREQUENCY: The Energy Absorbing Lanyard shall be inspected by the user before each use and, additionally, by a competent person⁴ other than the user at intervals of no more than one year⁵. Inspection procedures are described in the "Inspection Checklist" (Table 1). Results of each Competent Person inspection should be recorded on copies of the "Inspection and Maintenance Log" (lanyards) or tracked with the i-Safe system.

4.3 UNSAFE OR DEFECTIVE CONDITIONS: If inspection reveals an unsafe or defective condition, remove the lanyard from service and destroy. Lanyards are not repairable.

4.4 PRODUCT LIFE: The functional life of the lanyard is determined by work conditions and maintenance. As long as the lanyard passes inspection criteria, it may remain in service.

WARNING: Failure to properly inspect the lanyard could result in product failure and serious injury or death.

Table 1 – Inspection Checklist

Component:	Inspection: (See Section 4.2 for Inspection Frequency)	Pass	Fail
Lanyard Hardware	Inspect energy absorbing lanyard or energy absorber component hardware (snap hooks, adjusters, swages, thimbles, etc.). These items must not be damaged, broken, distorted, or have any sharp edges, burrs, cracks, worn parts, or corrosion. Ensure the connecting hooks work properly. Hook gates must move freely and lock upon closing. Ensure adjusters (if present) work properly.	<input type="checkbox"/>	<input type="checkbox"/>
Modular Lanyard Hardware	Inspect modular lanyard connection components for proper operation. Using the procedures in Section 3.3 of this instruction, confirm that female connector locks move freely when depressed and that they securely capture male connectors when the male and female components are assembled.	<input type="checkbox"/>	<input type="checkbox"/>

4 Competent Person: One who is capable of identifying existing and predictable hazards in the surroundings or working conditions which are unsanitary, hazardous, or dangerous to employees, and who has authorization to take prompt corrective measures to eliminate them.

5 Inspection Frequency: Extreme working conditions (harsh environments, prolonged use, etc.) may require increasing the frequency of competent person inspections.

Table 1 – Inspection Checklist

Webbing & Stitching (Figure 27)	The webbing material must be free of frayed, cut, or broken fibers. Check for tears, abrasions, mold, burns, or discoloration, etc. The webbing must be free of knots, excessive soiling, heavy paint buildup, and rust staining. Check for chemical or heat damage indicated by brown, discolored, or brittle areas. Check for ultraviolet damage indicated by discoloration and the presence of splinters or slivers on the webbing surface. All of the above factors are known to reduce webbing strength. Inspect stitching for pulled or cut stitches. Broken stitches may be an indication the energy absorbing lanyard or energy absorber component has been impact loaded and must be removed from service.	<input type="checkbox"/>	<input type="checkbox"/>
Wire Rope (Figure 28)	Inspect entire length of the wire rope. Always wear protective gloves when inspecting wire rope. Inspect for broken wires by passing cable through gloved hands, flexing it every few inches to expose breaks. Broken wires can be removed by bending the wire back and forth parallel to the rope length. Do not attempt to pull wires out of rope. Remove the energy absorbing lanyard from service immediately and destroy if there are six or more randomly distributed broken wires in one lay, or three or more broken wires in one strand in one lay. A "lay" of wire rope is the length of wire rope that it takes for a strand (the larger groups of wires) to complete one revolution or twist along the rope. Remove the energy absorbing lanyard from service immediately and destroy if there are any broken wires within 1 inch of the metal compression sleeves (swages) at either end of the assembly. The wire rope should be free of corrosion.	<input type="checkbox"/>	<input type="checkbox"/>
Energy Absorber & Impact Indication (Figure 29)	Inspect the energy absorber to determine if it has been activated. There should be no evidence of elongation. Ensure energy absorber cover is secure and not torn or damaged.	<input type="checkbox"/>	<input type="checkbox"/>
Labels	All labels should be present and fully legible (see Section 7 'Labeling').	<input type="checkbox"/>	<input type="checkbox"/>
System & Subsystem Components	Inspect each system component or subsystem according to manufacturer's instructions and confirm that it can continue to be used.	<input type="checkbox"/>	<input type="checkbox"/>

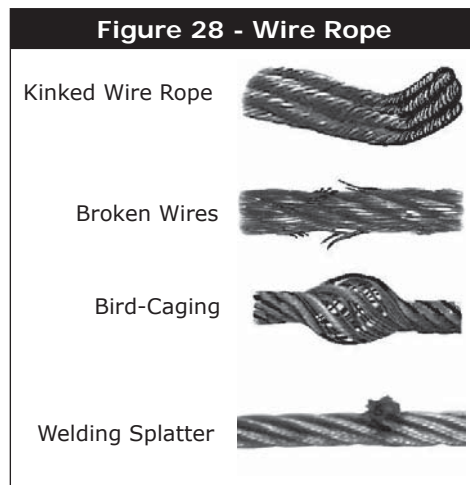
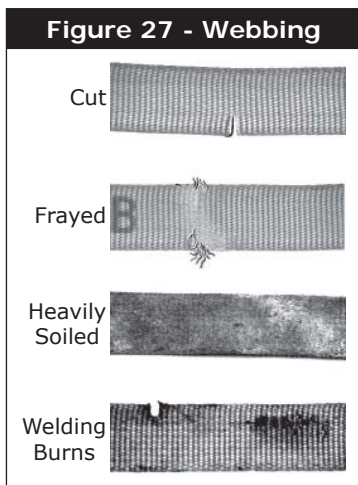
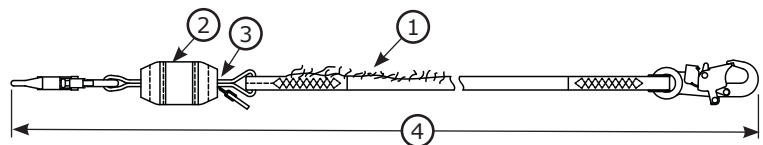

Figure 29 – Impact Indicators

The following items indicate the Energy Absorber has been subjected to impact loading and has been activated:

1. Torn webbing.
2. Torn or broken cover.
3. Open end or ripped out stitching.
4. Measured length is more than 15 cm (6 in.) longer than the length marked on the label.



5.0 MAINTENANCE, SERVICING, STORAGE

- 5.1 Clean lanyard with water and a mild detergent solution. Wipe off hardware with a clean, dry cloth, and hang to air dry. Do not force dry with heat. An excessive buildup of dirt, paint, etc., may prevent the lanyard from working properly, and in severe cases degrade the webbing or rope to a point where it has become weakened and should be removed from service. If you have any questions concerning the condition or cleaning of your lanyard, doubts about putting it into service or require more information, contact Capital Safety.
- 5.2 Additional maintenance and servicing procedures (replacement parts) must be completed by a factory authorized service center. Authorization must be in writing. Do not disassemble the unit. See Section 4.2 for inspection frequency.
- 5.3 Store the lanyard in a cool, dry, clean environment out of direct sunlight. Avoid areas where chemical vapors may exist. Thoroughly inspect the lanyard or energy absorber component after extended storage.

6.0 MODELS AND SPECIFICATIONS

Lanyard Model	Energy Absorber Specifications	Adjustable/ Fixed Length	Lanyard Specifications
EZ-Stop Energy Absorber Component	1 1/4 - 1 1/2 in. (3.2 - 3.8 cm) aromatic polyester web strength member, tubular polyester web wear pad (both ends), nylon outer cover, polyester thread, tensile strength greater than 5000 lbs.	Fixed	Not applicable.
Fixed Length EZ-Stop Web Leg Lanyards	1 1/4 - 1 1/2 in. (3.2 - 3.8 cm) aromatic polyester web strength member, tubular polyester web wear pad (both ends), nylon outer cover, polyester thread, tensile strength greater than 5000 lbs.	Fixed	3/4 - 1 in. (1.9 - 2.5 cm) polyester web, 8,000 - 9,800 lbs. (35.6 - 43.6 kN) tensile strength.
Adjustable Length EZ-Stop Web Leg Lanyards	1 1/4 - 1 1/2 in. (3.2 - 3.8 cm) aromatic polyester web strength member, tubular polyester web wear pad (both ends), nylon outer cover, polyester thread, tensile strength greater than 5000 lbs.	Adjustable	1 in. (2.5 cm) polyester web, 9,800 lbs. (43.6 kN) tensile strength.
EZ-Stop Cable Leg Lanyards	1 1/4 - 1 1/2 in. (3.2 - 3.8 cm) aromatic polyester web strength member, tubular polyester web wear pad (both ends), nylon outer cover, polyester thread, tensile strength greater than 5000 lbs.	Fixed	1/4 in. (.64 cm) diameter steel cable, galvanized, vinyl jacket, 7,000 lbs. (31.1 kN) tensile strength.
EZ-Stop Rope Leg Lanyards	1 1/4 - 1 1/2 in. (3.2 - 3.8 cm) aromatic polyester web strength member, tubular polyester web wear pad (both ends), nylon outer cover, polyester thread, tensile strength greater than 5000 lbs.	Fixed	1/2 in. (1.3 cm) nylon/polyester rope, 10,000 lbs. (44.5 kN) tensile strength.
EZ-Stop Elastic Leg Lanyards	1 1/4 - 1 1/2 in. (3.2 - 3.8 cm) aromatic polyester web strength member, tubular polyester web wear pad (both ends), nylon outer cover, polyester thread, tensile strength greater than 5000 lbs.	Fixed	1 3/8 in. (3.5 cm) tubular polyester web, elastic web, 6,600 lbs. (29.4 kN) tensile strength
EZ-Stop Resist Web Leg Lanyards	1 1/4 - 1 1/2 in. (3.2 - 3.8 cm) aromatic polyester web strength member, tubular polyester web wear pad (both ends), nylon outer cover, polyester thread, tensile strength greater than 5000 lbs.	Fixed	1 in. (2.5 cm) polyester web, polyurethane coated, 9,800 lbs. (43.6 kN) tensile strength.
EZ-Stop Tie-Back Web Leg Lanyards	1 1/4 - 1 1/2 in. (3.2 - 3.8 cm) aromatic polyester web strength member, tubular polyester web wear pad (both ends), nylon outer cover, polyester thread, tensile strength greater than 5000 lbs.	Fixed	1 in. (2.5 cm) polyester web, tubular polyester web cover, 9,800 lbs. (43.6 kN) tensile strength.
EZ-Stop WrapBax2 Web Leg Lanyards	1 1/4 - 1 1/2 in. (3.2 - 3.8 cm) aromatic polyester web strength member, tubular polyester web wear pad (both ends), nylon outer cover, polyester thread, tensile strength greater than 5000 lbs.	Fixed	1 3/6 in. (3.0 cm) nylon web, 13,000 lbs. (57.8 kN) tensile strength
EZ-Stop Modular Energy Absorber	1 1/4 - 1 1/2 in. (3.2 - 3.8 cm) aromatic polyester web strength member, tubular polyester web wear pad (both ends), nylon outer cover, polyester thread, tensile strength greater than 5000 lbs.	Fixed	Not applicable.
EZ-Stop Modular Lanyard Legs	Not applicable.	Fixed	Specific to lanyard model; see applicable lanyard leg specification.
EZ-Stop Arc Flash Fixed Length Web Leg Lanyards	1 1/4 - 1 1/2 in. (3.2 - 3.8 cm) aromatic polyester web strength member, tubular Nomex®/Kevlar® web wear pad (both ends), Nomex®/Kevlar® outer cover, Kevlar® thread, tensile strength greater than 5000 lbs.	Fixed	1 in. (2.5 cm) Kevlar® or polyurethane coated polyester web, 9,800 lbs. (43.6 kN) tensile strength.
Adjustable Length EZ-Stop Arc Flash Web Leg Lanyards	1 1/4 - 1 1/2 in. (3.2 - 3.8 cm) aromatic polyester web strength member, tubular Nomex®/Kevlar® web wear pad (both ends), Nomex®/Kevlar® outer cover, Kevlar® thread, tensile strength greater than 5000 lbs.	Adjustable	1 in. (2.5 cm) Kevlar® web, 9,800 lbs. (43.6 kN) tensile strength.
EZ-Stop Arc Flash Tie Back Web Leg Lanyards	1 1/4 - 1 1/2 in. (3.2 - 3.8 cm) aromatic polyester web strength member, tubular Nomex®/Kevlar® web wear pad (both ends), Nomex®/Kevlar® outer cover, Kevlar® thread, tensile strength greater than 5000 lbs.	Fixed	1 in. (2.5 cm) Kevlar® web, 9,800 lbs. (43.6 kN) tensile strength.
Shockwave2 Force2 Wind Energy Web Leg Lanyards	1 1/2 in. (3.8 cm) aromatic polyester web strength member, tubular polyester web wear pad (both ends), nylon outer cover, polyester thread, tensile strength greater than 5000 lbs.	Fixed	2 in. (5.0 cm) tubular polyester web strength member, 6,000 lbs. (26.7 kN) tensile strength.

6.1 LANYARD END HOOK SPECIFICATIONS

Hook	Description	Material	Gate Strength	Throat Size
2000023	Double Action Captive Eye Carabiner	Anodized Aluminum Alloy	3,600 lbs (16 kN)	0.75 in (1.9 cm)
2000118	Double Action Lock Rebar Snap Hook	Zinc Plated Steel	3,600 lbs (16 kN)	2.5 in (6.4 cm)
2000125	Double Action Lock Rebar Snap Hook	Zinc Plated Steel	3,600 lbs (16 kN)	3.0 in (7.6 cm)
2000209	Double Action Lock Rebar Snap Hook	Anodized Aluminum Alloy	3,600 lbs (16 kN)	2.5 in (6.4 cm)
2000210	Double Action Lock Rebar Snap Hook	Zinc Plated Steel	3,600 lbs (16 kN)	2.5 in (6.4 cm)
2100044	Swiveling Self-Locking Snap Hook with Impact Indicator	Stainless Steel	3,600 lbs (16 kN)	0.75 in (1.9 cm)
2109193	Double Action Lock Rebar Snap Hook	Zinc Plated Steel	3,600 lbs (16 kN)	2.5 in (6.4 cm)
9501804	Double Action WrapBax2 Snap Hook	Zinc Plated Steel	5,000 lbs (22 kN)	0.82 in (2.1 cm)
9502058	Double Action Lock Rebar Snap Hook	Anodized Aluminum Alloy	3,600 lbs (16 kN)	2.25 in (5.7 cm)
9502116	Double Action Lock Snap Hook	Zinc Plated Steel	3,600 lbs (16 kN)	0.75 in (1.9 cm)
9502573	Double Action Lock Snap Hook	Zinc Plated Steel	3,600 lbs (16 kN)	0.71 in (1.8 cm)
9505254	Double Action Lock Snap Hook	Anodized Aluminum Alloy	3,600 lbs (16 kN)	0.75 in (1.9 cm)

IMPORTANT: All systems, sub-systems and components marked with ANSI have been tested and qualified/verified in an ISO 17025 accredited lab per ANSI Z359.7.

6.2 This instruction applies to the following models:

WEB	1246078	1246140	1246198	1246251	1246272	LEADING	1246307
LANYARDS	1246079	1246141	1246199	1246252	1246273	EDGE	1246308
1246010	1246080	1246142	1246200	1246255	1246274	LANYARDS	1246309
1246011	1246081	1246143	1246201	1246256	1246275	1246066	1246310
1246012	1246083	1246144	1246202	1246263	1246276	1246067	1246311
1246013	1246085	1246145	1246203	1246264	1246277	1246068	1246312
1246014	1246086	1246147	1246204	1246265	1246278	1246069	1246313
1246015	1246087	1246148	1246205	1246266	1246279	1246178	1246314
1246016	1246088	1246149	1246206	1246267	1246280	1246260	1246315
1246017	1246089	1246150	1246207	1246268	1246281	1246261	1246316
1246018	1246090	1246151	1246208	1246269	1246284	1246262	1246317
1246019	1246091	1246152	1246212	1246339	1246285		1246318
1246020	1246093	1246153	1246213	1246349	1246286	CABLE	1246319
1246021	1246094	1246154	1246214	1246350	1246287	LANYARDS	1246320
1246022	1246098	1246155	1246215	1246351	1246290	1246135	1246321
1246023	1246100	1246156	1246216	1246356	1246291	1246136	1246322
1246024	1246101	1246157	1246217	1246357	1246294	1246181	1246323
1246024H	1246102	1246158	1246218	1246358	1246295	1246182	1246334C
1246025	1246103	1246159	1246221	1246359		1246183	1246336C
1246026	1246103H	1246160	1246225	1246360	MODULAR	1246184	1246337
1246027	1246104	1246161	1246226	1246361	LANYARDS	1246185	1246340
1246028	1246107	1246162	1246227	1246362	1246040	1246186	1246341
1246029	1246110	1246163	1246228	1246363	1246041	1246187	1246343
1246031	1246113	1246164	1246229	1246365	1246042	1246188	1246344
1246034	1246116	1246165	1246230	1246366	1246043	1246189	1246347
1246035	1246117	1246166	1246231	1246367	1246044	1246190	1246348
1246036	1246118	1246167	1246232	1246368	1246045	1246244	1246352
1246037	1246119	1246168	1246233	1246369	1246046	1246403	1246355
1246038	1246121	1246169	1246234	1246370	1246047		
1246039	1246122	1246170	1246235	1246371	1246048	ARC	WIND
1246053	1246123	1246171	1246236	1246372	1246049	FLASH	ENERGY
1246054	1246124	1246172	1246239	1246373	1246050	LANYARDS	LANYARDS
1256055	1246125	1246173	1246240	1246374	1246051	1246263	1246030
1246056	1246126	1246174	1246241	1246401	1246052	1246298	1246032
1246070	1246127	1246176	1246242	1246404	1246060	1246299	
1246070H	1246128	1246177	1246243	1246405	1246061	1246300	
1246071	1246129	1246180	1246245	1246406	1246064	1246301	
1246072	1246130	1246192	1246246	5002045	1246065	1246302	
1246073	1246133	1246193	1246247	ROPE	1246076	1246303	
1246074	1246137	1246194	1246248	LANYARDS	1246402	1246304	
1246075	1246138	1246196	1246249	1246270		1246305	
1246077	1246139	1246197	1246250	1246271		1246306	

7.0 LABELING

ALL EZ-STOP LANYARD MODELS: Warning, Use, Identification and Inspection labels are located on and inside a protective cover on the back side of the lanyard energy absorber. Pull **Tab** to open the cover and expose the labels.

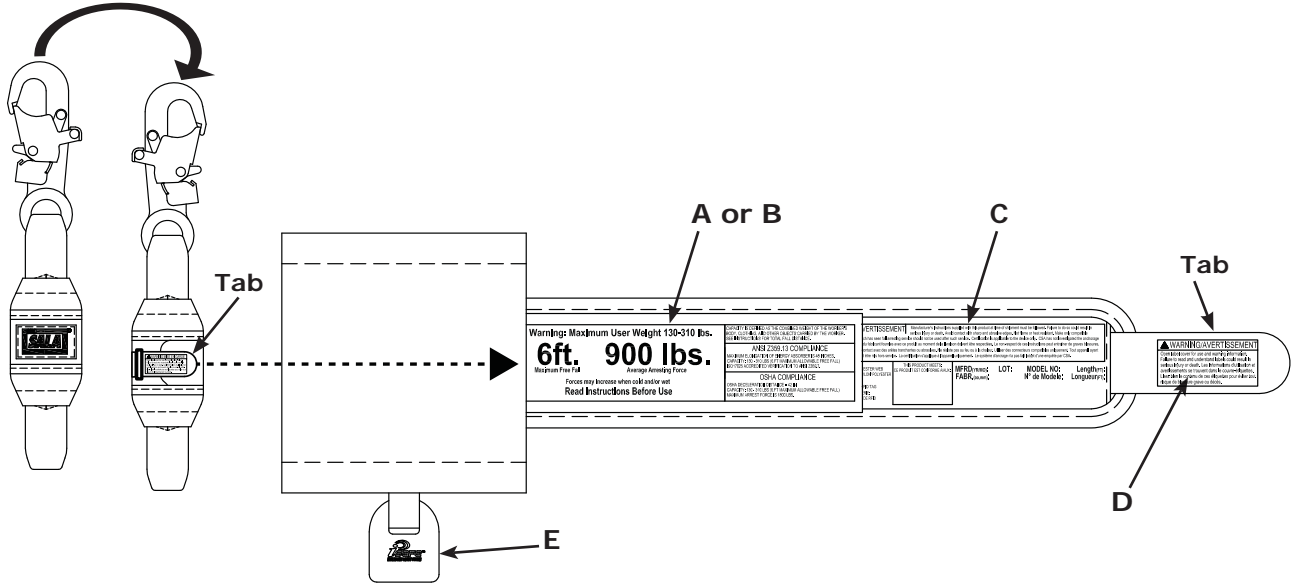

Warning: Maximum User Weight 130-310 lbs.
6ft. 900 lbs.
 Maximum Free Fall Average Arresting Force
 Maximum Deployment Distance 48"
 Forces may increase when cold and/or wet
 Read Instructions Before Use

ANSI Z359.13 COMPLIANCE
 MAXIMUM ELONGATION OF ENERGY ABSORBER IS 48 INCHES.
 CAPACITY: 130-310 LBS (6 FT MAXIMUM ALLOWABLE FREE FALL)
 ISO/IEC ACCREDITED VERIFICATION TO ANSI Z359.7.

OSHA COMPLIANCE
 OSHA DECELERATION DISTANCE = 42 IN.
 CAPACITY: 130-310 LBS (6 FT MAXIMUM ALLOWABLE FREE FALL)
 MAXIMUM ARREST FORCE IS 900 LBS.

9507746 Rev. B

Warning: Maximum User Weight 130-310 lbs.
12ft. 1350 lbs.
 Maximum Free Fall Average Arresting Force
 Maximum Deployment Distance 60"
 Forces may increase when cold and/or wet
 Read Instructions Before Use

ANSI Z359.13 COMPLIANCE
 MAXIMUM ELONGATION OF ENERGY ABSORBER IS 60 INCHES.
 CAPACITY: 130-310 LBS (12 FT MAXIMUM ALLOWABLE FREE FALL)
 ISO/IEC ACCREDITED VERIFICATION TO ANSI Z359.7.

OSHA COMPLIANCE
 OSHA DECELERATION DISTANCE = 42 IN.
 CAPACITY: 130-310 LBS (12 FT MAXIMUM ALLOWABLE FREE FALL)
 MAXIMUM ARREST FORCE IS 1350 LBS.

9507746 Rev. B

A: Warning/Use, ANSI models, EZ-Stop

B: Warning/Use, ANSI models, EZ-Stop Force2

DBI SALA www.capitalsafety.com
 Capital Safety
 Red Wing, MN, USA
 +1-800-328-6146

DO NOT REMOVE THIS LABEL
 NE PAS ENLEVER CETTE
 ÉTIQUETTE

INSPECTION LOG
 RELEVÉ D'INSPECTION

DATE	INIT.	DATE	INIT.

PATENT PENDING / BREVET EN INSTANCE

WARNING / AVERTISSEMENT Manufacturer's instructions supplied with this product at time of shipment must be followed. Failure to do so could result in serious injury or death. Avoid contact with sharp and abrasive edges. Polyester and nylon models are not flame or heat resistant. Make only compatible connections. Any unit which has seen fall arresting service should not be used after such service. Certification is applicable to the device only. CSA has not investigated the anchorage system. Les instructions du fabricant fournies avec ce produit au moment de la livraison doivent être respectées. Le non-respect de ces instructions peut entraîner de graves blessures, voire la mort. Éviter tout contact avec des arêtes tranchantes ou abrasives. Les modèles en polyester et nylon ne sont pas résistants aux flammes ou à la chaleur. Utilisez des connecteurs compatibles uniquement. Tout appareil ayant subi un arrêt de chute doit être mis hors service. La certification s'applique à l'appareil uniquement. Le système d'ancrage n'a pas fait l'objet d'une enquête par CSA.

Serial no: SEE RFID TAG Numéro de série: VOIR L'ÉTIQUETTE DE RFID	This product meets: Ce produit est conforme à/aux:	Mfrd. (yr.mo): Fabr. (aa.mm): Model No.: N° de Modèle: Length(ft): Longueur(pi):	Lot: Materials / Matériaux:
--	---	---	--------------------------------

9507746 Rev. E

C: Warning/Inspection, on protective cover

WARNING/AVERTISSEMENT

Open label cover for use and warning information. Failure to read and understand labels could result in serious injury or death. Les informations d'utilisation et d'avertissements se trouvent dans le couvre-étiquettes. Lisez bien le contenu de ces étiquettes pour éviter tout risque de blessure grave ou décès.



D: Warning, on protective cover tab

E: iSafe RFID Tag, attached to protective cover; also on some lanyard legs.

WARNING

Manufacturer's instructions supplied with this product at time of shipment must be read and understood prior to use. This lanyard shall only be used with compatible DBI-SALA modular energy absorbers. Inspect all connections prior to use and verify modular connecting components are installed correctly. Failure to make secure connections could result in serious injury or death. Not flame or heat resistant unless otherwise specified. Avoid contact with sharp and abrasive edges. Any unit which has seen fall arresting service should not be used after such service. Do not remove this label.

MODEL NO / N° DE MODELE:
LOT NO / N° DE LOT:
MFRD (YR/MO) / FABR. (AN/MO):
LENGTH / LONGUEUR (FT)/M:
MATERIAL / MATERIAU:

AVERTISSEMENT

Avant toute utilisation, s'assurer de bien lire et de comprendre les instructions du fabricant fournies avec ce produit au moment de la livraison. Cette longe ne devrait être utilisée qu'avec des absorbeurs d'énergie modulaire DBI-SALA compatibles. Avant utilisation, vérifier toutes les connexions et vérifier que tous les composants des connexions modulaires sont correctement installés. L'absence de connexions sécurisées pourrait provoquer des blessures graves, voire la mort. Ne résiste pas aux flammes et au feu, sauf indication contraire. Éviter tout contact avec des arêtes tranchantes ou abrasives. Tout appareil ayant subi un arrêt de chute doit être mis hors service. Ne pas retirer cette étiquette.



www.capitalsafety.com
 Capital Safety
 Red Wing, MN USA
 +1-800-328-6146

9507750 Rev. A

Warning/Use, ANSI models, EZ-Stop Modular Lanyard Leg Component

INDIVIDUAL LABELS, IDENTIFIED BY MODEL TYPE:

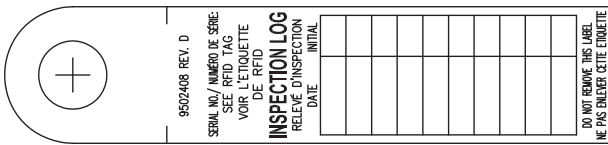

Inspection Log Label, all models

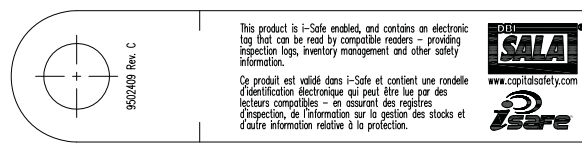

iSafe Label, all models

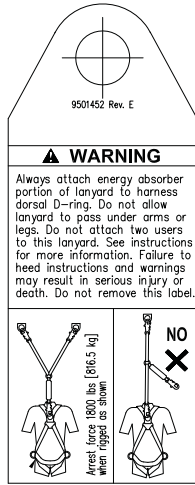

Front



Back

Warning/Use, Twin Leg models

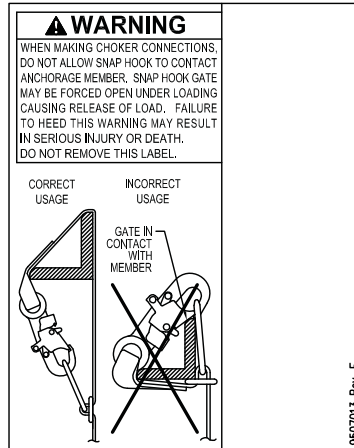

9507013 Rev. E

Warning/Use, Tie-Back models

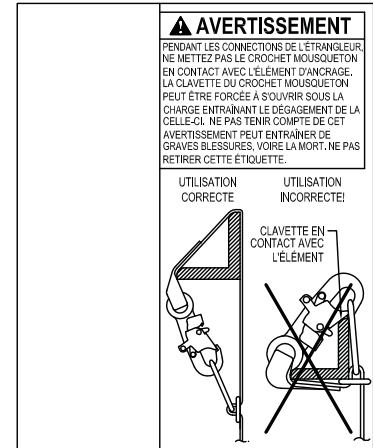

Front

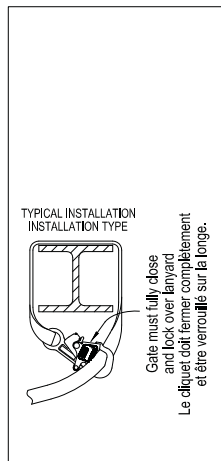

Back

Warning/Use, WrapBax models



Warning/Use, WrapBax models

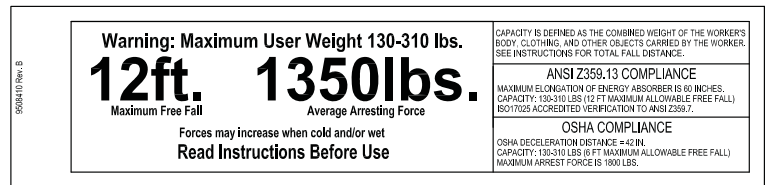

Warning/Use, Leading Edge models



Front

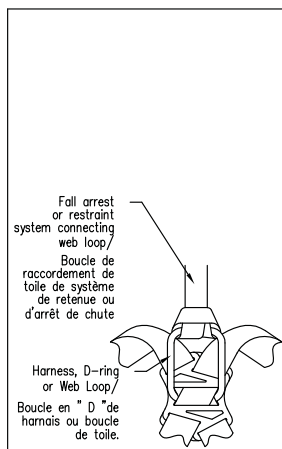

Back

Warning/Use, Connecting Loop models

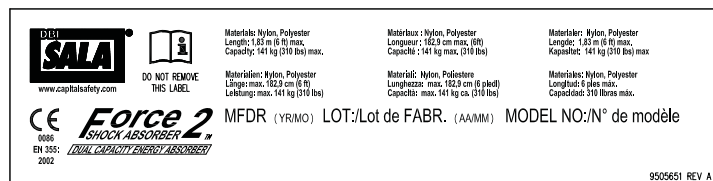

Material Specifications, Shockwave2 Force2 Wind Energy models

LIMITED LIFETIME WARRANTY

Warranty to End User: D B Industries, LLC dba CAPITAL SAFETY USA ("CAPITAL SAFETY") warrants to the original end user ("End User") that its products are free from defects in materials and workmanship under normal use and service. This warranty extends for the lifetime of the product from the date the product is purchased by the End User, in new and unused condition, from a CAPITAL SAFETY authorized distributor. CAPITAL SAFETY'S entire liability to End User and End User's exclusive remedy under this warranty is limited to the repair or replacement in kind of any defective product within its lifetime (as CAPITAL SAFETY in its sole discretion determines and deems appropriate). No oral or written information or advice given by CAPITAL SAFETY, its distributors, directors, officers, agents or employees shall create any different or additional warranties or in any way increase the scope of this warranty. CAPITAL SAFETY will not accept liability for defects that are the result of product abuse, misuse, alteration or modification, or for defects that are due to a failure to install, maintain, or use the product in accordance with the manufacturer's instructions.

CAPITAL SAFETY'S WARRANTY APPLIES ONLY TO THE END USER. THIS WARRANTY IS THE ONLY WARRANTY APPLICABLE TO OUR PRODUCTS AND IS IN LIEU OF ALL OTHER WARRANTIES AND LIABILITIES, EXPRESSED OR IMPLIED. CAPITAL SAFETY EXPRESSLY EXCLUDES AND DISCLAIMS ANY IMPLIED WARRANTIES OF MERCHANTABILITY OR FITNESS FOR A PARTICULAR PURPOSE, AND SHALL NOT BE LIABLE FOR INCIDENTAL, PUNITIVE OR CONSEQUENTIAL DAMAGES OF ANY NATURE, INCLUDING WITHOUT LIMITATION, LOST PROFITS, REVENUES, OR PRODUCTIVITY, OR FOR BODILY INJURY OR DEATH OR LOSS OR DAMAGE TO PROPERTY, UNDER ANY THEORY OF LIABILITY, INCLUDING WITHOUT LIMITATION, CONTRACT, WARRANTY, STRICT LIABILITY, TORT (INCLUDING NEGLIGENCE) OR OTHER LEGAL OR EQUITABLE THEORY.



Fall Protection

USA

3833 SALA Way
Red Wing, MN 55066-5005
Toll Free: 800.328.6146
Phone: 651.388.8282
Fax: 651.388.5065
solutions@capitalsafety.com

Brazil

Rua Anne Frank, 2621
Boqueirão Curitiba PR
81650-020
Brazil
Phone: 0800-942-2300
brasil@capitalsafety.com

Mexico

Calle Norte 35, 895-E
Col. Industrial Vallejo
C.P. 02300 Azcapotzalco
Mexico D.F.
Phone: (55) 57194820
mexico@capitalsafety.com

Colombia

Compañía Latinoamericana de Seguridad S.A.S.
Carrera 106 #15-25 Interior 105 Manzana 15
Zona Franca - Bogotá, Colombia
Phone: 57 1 6014777
servicioalcliente@capitalsafety.com

Canada

260 Export Boulevard
Mississauga, ON L5S 1Y9
Phone: 905.795.9333
Toll-Free: 800.387.7484
Fax: 888.387.7484
info.ca@capitalsafety.com

EMEA (Europe, Middle East, Africa)

EMEA Headquarters:
5a Merse Road
North Moons Moat
Redditch, Worcestershire
B98 9HL UK
Phone: + 44 (0)1527 548 000
Fax: + 44 (0)1527 591 000
csgne@capitalsafety.com

France:

Le Broc Center
Z.I. 1re Avenue - BP15
06511 Carros Le Broc Cedex
France
Phone: + 33 04 97 10 00 10
Fax: + 33 04 93 08 79 70
information@capitalsafety.com

Australia & New Zealand

95 Derby Street
Silverwater
Sydney NSW 2128
Australia
Phone: +(61) 2 8753 7600
Toll-Free : 1800 245 002 (AUS)
Toll-Free : 0800 212 505 (NZ)
Fax: +(61) 2 8753 7603
sales@capitalsafety.com.au

Asia

Singapore:

69, Ubi Road 1, #05-20
Oxley Bizhub
Singapore 408731
Phone: +65 - 65587758
Fax: +65 - 65587058
inquiry@capitalsafety.com

Shanghai:

Rm 1406, China Venturetech Plaza
819 Nan Jing Xi Rd,
Shanghai 200041, P R China
Phone: +86 21 62539050
Fax: +86 21 62539060
inquiry@capitalsafety.cn

www.capitalsafety.com

