



**A Capital
Safety
Brand**



**PRO SERIES
SHOCK ABSORBING
LANYARD**

This manual is intended to meet the Manufacturer's Instructions as required by the following standards and should be used as part of an employee training program as required by OSHA:



ANSI Z359.1



CSA Z259.11

WARNING: This product is part of a personal restraint, work positioning, suspension, or rescue system. The user must read and follow the manufacturer's instructions for each component or part of the complete system. These instructions must be provided to the user of this equipment. The user must read and understand these instructions or have them explained to them before using this equipment. Manufacturer's instructions must be followed for proper use and maintenance of this product. Alterations or misuse of this product or failure to follow instructions may result in serious injury or death.

IMPORTANT: If you have any questions on the use, care, application, or suitability for use of this equipment, contact CAPITAL SAFETY.

IMPORTANT: Before using this equipment record the product identification information (from the I.D. label) onto the inspection and maintenance log.

PURPOSE: PROTECTA Energy Absorbing Lanyards and Energy Absorbers are intended to be used as part of a personal fall arrest system. Applications include activities where there exists the possibility of a fall.

LIMITATIONS: Consider the following application limitations before using this equipment:

CAPACITY: This equipment is for use by one person with a combined weight (refer to standard).

PHYSICAL AND ENVIRONMENTAL HAZARDS:

Use of this equipment in areas containing physical or environmental hazards may require that additional precautions be taken to reduce the possibility of damage to this equipment or injury to the user. Hazards may include, but are not limited to: high heat, strong or caustic chemicals, corrosive environments, the possibility of electric current flowing through this equipment when working near high voltage power lines, explosive or toxic gases, moving machinery, or sharp edges. Contact CAPITAL SAFETY if you have any questions about the application of this equipment

TRAINING: This equipment is intended to be installed and used by persons who have been properly trained in its correct application and use.

APPLICABLE STANDARDS: Refer to national standards including ANSI Z359.1, CSA Z259.11 (Canada), and local, state, federal (OSHA 1910.66 and 1926.500), and Capital Safety requirements for more information.

COMPATIBILITY OF COMPONENTS: PROTECTA equipment is designed for use with PROTECTA approved components and subsystems only. Substitutions may jeopardize compatibility of equipment and effect the safety and reliability of the system.

COMPATIBILITY OF CONNECTORS: Connectors are considered to be compatible with connecting elements when they have been designed to work together in such a way that their sizes and shapes do not cause their gate mechanisms to inadvertently open regardless of how they become oriented.

Connectors (hooks, carabiners, and D-rings) must be capable of supporting at least 5,000 lbs. (22.2 kN). Connectors must be compatible with the anchorage or other system components. Do not use equipment

that is not compatible. Non-compatible connectors may unintentionally disengage. See Figure 1. Connectors must be compatible in size, shape, and strength.

MAKING CONNECTIONS: Only use self-locking snap hooks and carabiners. Only use connectors that are suitable to each application. Ensure all connections are compatible in size, shape and strength. Ensure all connectors are fully closed and locked.

See Figure 2 for inappropriate connections. PROTECTA snap hooks and carabiners should not be connected:

To a D-ring to which another connector is attached and in a manner that would result in a load on the gate.

NOTE: Unless equipped with a 3600 lb. (16kN) rated gates, large throat-opening snap hooks should not be connected to standard size D-rings or similar objects which will result in a load on the gate if the hook or D-ring twists or rotates. Large throat snap hooks are designed for use on fixed structural elements such as rebar or cross members that are not shaped in a way that can capture the gate of the hook.

In a false engagement, where features that protrude from the snap hook or carabiner catch on the anchor, and without visual confirmation seems to be fully engaged to the anchor point or to each other.

Directly to webbing or rope lanyard or tie-back (unless the manufacturer's instructions for both the lanyard and connector specifically allows such a connection).

To any object which is shaped or dimensioned such that the snap hook or carabiners will not close and lock, or that roll-out could occur.

FIGURE 1

If the connecting element that a snap hook (shown) or carabiner attaches to is undersized or irregular in shape, a situation could occur where the connecting element applies a force to the gate of the snap hook or carabiner. This force may cause the gate (of either a self-locking or a non-locking snap hook) to open, allowing the snap hook or carabiner to disengage from the connecting point.

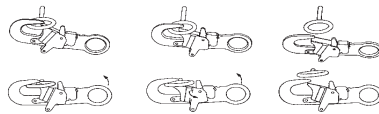

1. Force is applied to the snap hook.
2. The gate presses against the connecting ring.
3. The gate opens allowing the snap hook to slip off.

ANCHORAGE STRENGTH: Anchorages selected for personal fall arrest systems (PFAS) shall have a strength capable of sustaining static loads, applied in the directions permitted by the PFAS, of at least: (A) 3,600 lbs. (16 kN) when certification exists (reference ANSI Z359.1 for certification definition), or (B) 5,000 lbs. (22.2 kN) in the absence of certification. When more than one PFAS is attached to an anchorage, the anchorage strengths set forth in (A) and (B) above must be multiplied by the number of PFAS attached to the anchorage.

From OSHA 1926.500 and 1910.66: Anchorages used for attachment of PFAS shall be independent of any anchorage being used to support or suspend platforms, and capable of supporting at least 5,000 lbs. (22.2 kN) per user attached, or be designed, installed, and used as part of a complete PFAS, which maintains a safety factor of at least two, and is supervised by a qualified person.

Figure 2

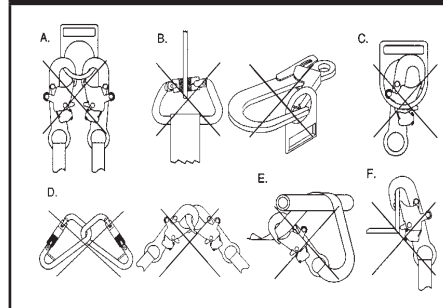

WARNING: Do not alter or intentionally misuse this equipment. Use caution when using around moving machinery, electrical hazards, chemical hazards, and sharp edges.

WARNING: Consult your doctor if there is reason to doubt your fitness to safely absorb the shock from a fall arrest. Age and fitness seriously affect a worker's ability to withstand falls. Pregnant women or minors must not use PROTECTA energy absorbing lanyards.

BEFORE EACH USE of this equipment, carefully inspect it to assure that it is in good working condition. Check for wear or damage. Ensure hardware is present and secure, and is not distorted. Ensure self-locking snap hooks or carabiners work properly. Inspect rope or webbing for wear, cuts, burns, frayed edges, breaks, or other damage. Do not use if inspection reveals an unsafe condition.

PLAN your fall protection system before starting your work. Take into consideration factors that affect your safety before, during, and after a fall. Consider the following when planning your system:

ANCHORAGE: Select a rigid anchorage point that is capable of supporting the required loads. The anchorage location must be carefully selected to reduce possible free fall and swing fall hazards and to avoid striking an object during a fall. The anchorage should be generally level (horizontal) to prevent the connector from sliding down an incline when in use, which could cause serious injury to the user.

FREE FALL: Personal fall arrest systems must be rigged such that the potential free fall is never greater than 6 feet (1.83 m). Avoid working above your anchorage level to avoid an increased free fall distance.

FALL ARREST FORCES: The assembled fall arrest system must keep fall arrest forces below 1,800 lbs. (8 kN) when used with a full body harness.

FALL CLEARANCE: Should a fall occur, there must be sufficient clearance in the fall area to arrest the fall before striking the ground or other object. Energy absorbers can extend the fall arrest distance by up to 42 inches (107 cm). Figure 3 shows how to estimate fall clearance distance when using an energy absorbing lanyard or energy absorber subsystem. Other factors may influence the required clearance distances. For example, using an energy absorbing lanyard or energy absorber with a rope grab (fall arrestor) may require additional clearance due to stretch in the lifeline or sliding of the rope grab on the lifeline during fall arrest. Some full body harness models incorporate a sliding (positional) D-ring in the back as the fall arrest attachment. Movement of this D-ring during fall arrest can increase the fall clearance distance required. Use caution when assembling system components that could act to extend the fall arrest distance (and therefore fall clearance required). Refer to manufacturer's instructions for each part of the system for more information on fall clearance.

Figure 3

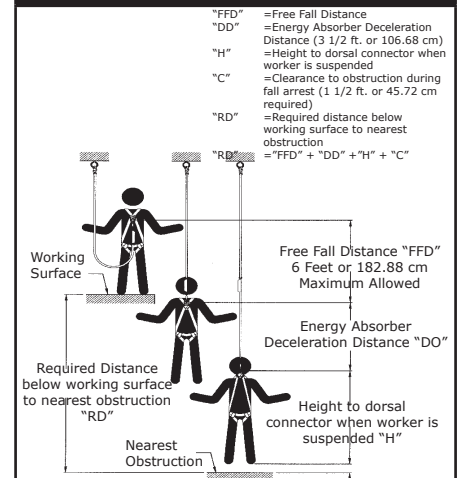

SWING FALLS: See Figure 4. Swing falls occur when the anchorage point is not directly above the point where a fall occurs. The force of striking an object in a swing fall may cause serious injury or death. Minimize swing falls by working as close to the anchorage point as possible. Do not permit a swing fall if injury could occur.

SHARP EDGES: Avoid will be in contact with, or abrade against, unprotected sharp edges. Do not loop lanyard around small diameter structural members. If working with this equipment near sharp edges is unavoidable, protection against cutting must be provided by using a heavy pad or other means over the exposed sharp edge.

RESCUE: Should a fall occur, the user (employer) must have a rescue plan and the ability to implement it.

AFTER A FALL: Lanyards with integral energy absorbers, or energy absorber components which have been subjected to the forces of arresting a fall must be removed from service and destroyed.

WARNING: Read and follow manufacturer's instructions for associated equipment (full body harness, rope grab, etc.) used in your fall protection system.

IMPORTANT: For special (custom) versions of this product, follow the instructions herein. If included, see supplement for additional instructions

MAKING CONNECTIONS: See Figure 5 for hook operation. Do not use hooks or connectors that will not completely close over the attachment object. For these situations, use a tie-off adaptor or other anchorage connector to allow a compatible connection. Do not tie knots of any type in lanyards, and do not hook a lanyard back into itself (choker style). Snap hooks and carabiners must not be connected to each other. Do not attach snap hooks to web loops.

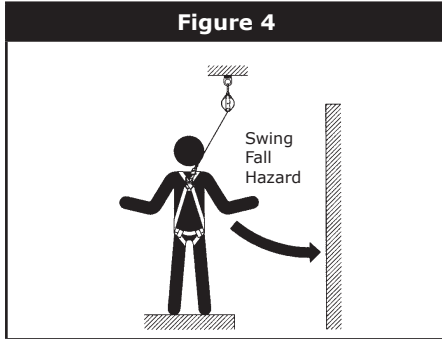

CONNECTING TO ANCHORAGE OR ANCHORAGE CONNECTOR: See Figure 6. Always connect the energy absorber end of the lanyard to the body support (harness). Connect the lanyard end to the anchorage or anchorage connector.

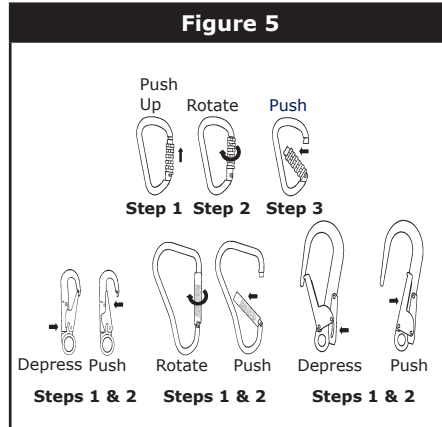

100% Tie Off Lanyard Considerations: Commonly known as 100% tie-off, "Y" type, twin leg, or double lanyards, these energy absorbing lanyards can be used to provide continuous fall protection while moving. With one lanyard leg attached, the worker can move to a new location. Attach the unused lanyard leg and disconnect attached leg. This procedure is repeated until new location is reached. Other practices that must be followed in order to use a 100% tie-off type lanyard safely include:

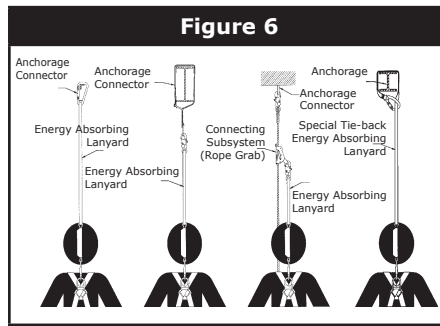

The energy absorber portion of the lanyard must be connected to the dorsal D-ring only. Use only the snap hook (or other connector provided) to attach the energy absorber portion directly to the harness dorsal D-ring. See Figures 7 and 8. Do not connect the energy absorber to the anchorage. See Figure 9. Do not attach the unused leg of the lanyard back to the harness at any location unless a specially designed lanyard retainer is provided for this purpose. Connection of both lanyard legs to separate anchorage points is acceptable. See Figure 10. Never connect more than one person to a "Y" type lanyard at a time. Do not allow any lanyard to pass under arms or legs during use.

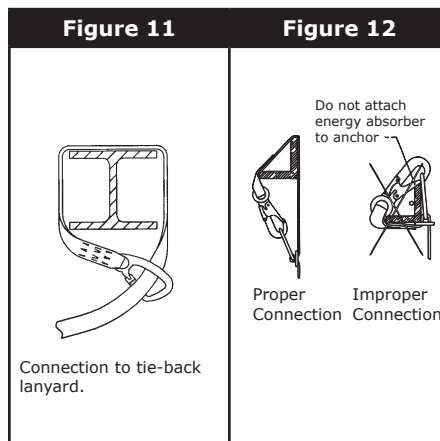
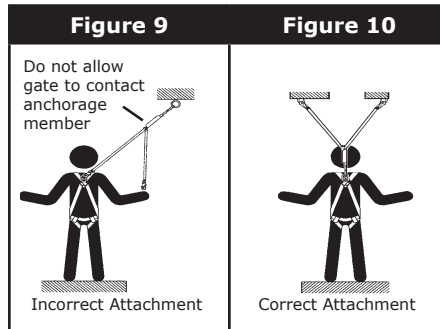
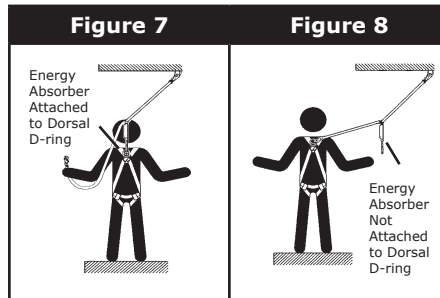

ATTACHING A TIE-BACK LANYARD: When using a PROTECTA tie-back lanyard, wrap the lanyard around an appropriate anchor, then open the gate of the carabiner and pass the lanyard through the carabiner. See Figure 11. The lanyard may make more than one wrap around the anchor, but the lanyard may only be passed through the carabiner once. Make sure the lanyard is captured and the gate closes completely.

WARNING: This style of lanyard uses high strength webbing and a special carabiner that has a high strength gate. Do not tie back other lanyard types.

ATTACHING A D-RING TIE-BACK LANYARD: See Figure 12. Place the tie-back lanyard over the anchoring structure. Ensure the lanyard is not twisted. Adjust the floating D-ring so it hangs below the anchoring structure. Attach the lanyard end hook to the floating D-ring. Make sure the connecting hook or carabiner closes completely and locks.

CONNECTING TO THE BODY SUPPORT: Connect the energy absorbing lanyard or energy absorber to the D-ring on the back between the shoulders (dorsal D-ring) on a full body harness. Connect so the energy absorber portion of the lanyard is on the harness side.

Attaching a Lanyard with Web Loops: See Figure 13. Insert the energy absorbing lanyard web loop through the harness web loop or D-ring. Insert the opposite end of the energy absorbing lanyard through the lanyard web loop. Pull the attached energy absorbing lanyard through the lanyard web loop to secure it.

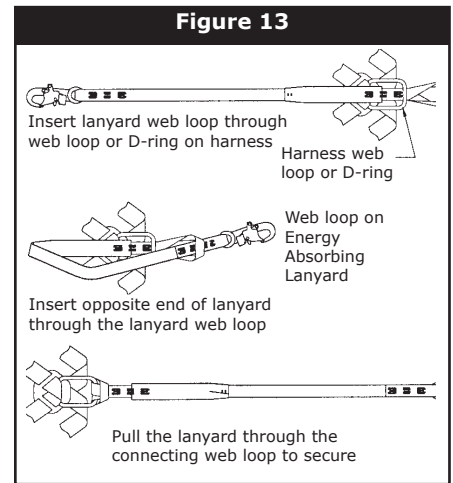

CONNECTING TO A ROPE GRAB (FALL ARRESTOR): Connect the lanyard end (vs. the energy absorber end) to the rope grab. Attaching a component style energy absorber to a rope grab is not recommended, with the exception of a "direct-coupling" between a rope grab and a harness. Some rope grabs may be supplied with a permanently attached energy absorbing lanyard. For these cases, use of an additional energy absorber is not recommended. Ensure the length of the energy absorber or energy absorbing lanyard does not exceed the rope grab manufacturer's recommended maximum connection length (3 feet or 91.44 cm maximum per ANSI Z359.1, 2 feet or 60.96 cm maximum per CSA Z259.2:1 Class AD).

CONNECTING TO SELF RETRACTING LIFELINE: PROTECTA does not recommend connecting an energy absorbing lanyard or energy absorber component to a self retracting lifeline. Special applications do exist where it may be permissible. Contact CAPITAL SAFETY if considering connecting an energy absorbing lanyard to a self retracting lifeline. After use, return the lanyard for cleaning or storage as described.

It is the responsibility of all users of this equipment to understand these instructions, and to be trained in the correct installation, use, and inspection of this equipment. These individuals must be aware of the consequences of improper installation or use of this equipment. This user manual is not a substitute for a comprehensive training program. Training must be provided on a periodic basis to ensure proficiency of the users.

IMPORTANT: Training must be conducted without exposing the trainee to a fall hazard. Training should be repeated on a periodic basis.

Before Each Use, visually inspect per steps listed. The lanyard must be inspected by a competent person* other than the user at least annually. Record the results of each formal inspection onto the inspection and maintenance log.

*Competent person: An individual knowledgeable of a manufacturer's recommendations, instructions and manufactured components who is capable of identifying existing and predictable hazards in the proper selection, use and maintenance of fall protection.

IMPORTANT: If the energy absorbing lanyard or energy absorber component has been subjected to fall arrest or impact forces, it must be immediately removed from service and destroyed.

IMPORTANT: Extreme working conditions (harsh environment, prolonged use, etc.) may require increasing the frequency of inspections.

INSPECTION STEPS: Inspect energy absorbing lanyard or energy absorber component hardware (snap hooks, adjusters, swages, thimbles, etc.). These items must not be damaged, broken, distorted, or have any sharp edges, burrs, cracks, worn parts, or corrosion. Ensure the connecting hooks work properly. Hook gates must move freely and lock upon closing. Ensure adjusters (if present) work properly.

Inspect the energy absorbing lanyard or energy absorber component per the following as applicable:

WEBBING AND STITCHING: The webbing material must be free of frayed, cut, or broken fibers. Check for tears, abrasions, mold, burns, or discoloration, etc. The webbing must be free of knots, excessive soiling, heavy paint buildup, and rust staining. Check for chemical or heat damage indicated by brown, discolored, or brittle areas. Check for ultraviolet damage indicated by discoloration and the presence of splinters or slivers on the webbing surface. All of the above factors are known to reduce webbing strength. Damaged or questionable webbing should be replaced. Inspect stitching for pulled or cut stitches. Broken stitches may be an indication the energy absorbing lanyard or energy absorber component has been impact loaded and must be removed from service. See Figure 14.

Inspect rope for concentrated wear. Material must be free of frayed strands, broken yarns, cuts, abrasions, burns, and discoloration. The rope must be free of knots, excessive soiling, paint build-up, and rust staining. Rope splices must be tight, with five full tucks, and thimbles must be held firmly by the splice. Check for chemical or heat damage; indicated by brown, discolored, or brittle areas. Check for ultraviolet damage; indicated by discoloration and splinters and slivers along the rope surface. All of the above factors are known to reduce rope strength. Damaged or questionable rope should be replaced.

WIRE ROPE: Inspect entire length of the wire rope. Always wear protective gloves when inspecting wire rope. Inspect for broken wires by passing cable through gloved hands, flexing it every few inches to expose breaks. Broken wires can be removed by bending the wire back and forth parallel to the rope length. Do not attempt to pull wires out of rope. Remove the energy absorbing lanyard from service immediately and destroy if there are six or more randomly distributed broken wires in one lay, or three or more broken wires in one strand in one lay. A "lay" of wire rope is the length of wire rope that it takes for a strand (the larger groups of wires) to complete one revolution or twist along the rope. Remove the energy absorbing lanyard from service immediately and destroy if there are any broken wires within 1 inch of the assembly. The wire rope should be free of corrosion.

ENERGY ABSORBING COMPONENT: Inspect energy absorber to determine if it has been activated. There should be no evidence of elongation. See Figure 14. Ensure energy absorber cover is secure and not torn or damaged. On the PRO Stretch™ Lanyard models, the lanyard webbing will tear out to reveal the warning on the impact indicator label. See Page 4 for label illustration. All labels should be present and fully legible.

Warranty

Equipment offered by CAPITAL SAFETY is warranted against factory defects in workmanship and materials for a period of two years from the date of installation or use by the owner, provided that this period shall not exceed two years from the date of shipment. Upon notice in writing, CAPITAL SAFETY will promptly repair or replace all defective items. CAPITAL SAFETY reserves the right to inspect any defective item returned to its plant before making a repair or replacement. This warranty does not cover equipment damages resulting from abuse, damage in transit, or other damage beyond the control of CAPITAL SAFETY. This warranty applies only to original purchaser and is applicable to our products in lieu of all other warranties expressed or implied.

Figure 14

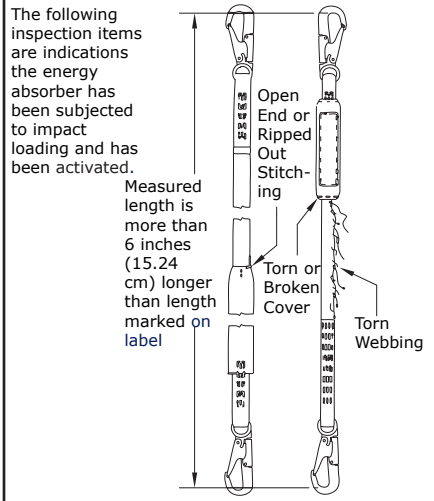

Inspect each system component or subsystem per associated manufacturer's instructions.

Record the inspection date and results onto the inspection and maintenance log found on Page 4 of this manual.

If inspection reveals an unsafe condition, remove unit from service immediately and destroy, or contact an authorized service center for repair.

NOTE: Only CAPITAL SAFETY or parties authorized in writing may make repairs to this equipment.

Clean lanyard with water and a mild detergent solution. Wipe off hardware with a clean, dry cloth, and hang to air dry. Do not force dry with heat. If you have any questions regarding cleaning of this equipment, or require more information, contact CAPITAL SAFETY. An excessive buildup of dirt, paint, etc., may prevent the lanyard from working properly, and in severe cases degrade the webbing or rope to a point where it has become weakened and should be removed from service. If you have any questions concerning the condition of your lanyard, or have any doubt about putting it into service, contact CAPITAL SAFETY.

Additional maintenance and servicing procedures (replacement parts) must be completed by a factory authorized service center. Authorization must be

in writing. Do not disassemble the unit. See the Inspection section for inspection frequency.

Store the lanyard in a cool, dry, clean environment out of direct sunlight. Avoid areas where chemical vapors may exist. Thoroughly inspect the lanyard or energy absorber component after extended storage.

Materials	PROTECTA energy absorbing lanyards may be constructed of one or a combination of the following materials:
Lanyard Leg	1-in. polyester web, 1 in. and 1 3/4-in. Kevlar® web, 1/2-in. diameter nylon rope, 1 3/8-in. tubular polyester web, 1 15/16-in. tubular polyester web, 1/4-in. coated galvanized or stainless steel cable.
Connectors	Forged steel, zinc/nickel/chromium plated, 1-in. nylon web loops.
Shock Absorber	1 3/4-in. nylon or polyester web, 1-in. polyester web.
Performance	Maximum Arrest force 900 lbs (4 kN) Maximum Elongation 42 inches (1.1 m)

This instruction applies to the following models:

AB17531	1340101	1342250
AB17532	1340121	1342275
AB17534	1340141	1350150
AB17535	1340161	1350200
AB17536	1340180	1351001
AB17537	1340181	1351050
AB17538	1340182	1360040
AB17539	1340200	1360060
AC27900	1340220	1360080
AE57610	1340221	1360180
AE57612	1340222	1360182
AE57620	1340223	1360200
AE57630	1340224	1360401
AE57640	1340225	1360451
AE57700	1340226	1360452
AE57701	1340230	1361050
AE57702	1340240	1361051
AE57800	1340250	1361052
AE57801	1340270	1361101
AE57802	1340401	1361125
AE57830	1340402	1362001
AE57831	1340403	1362002
AE57631	1340451	1362101
1330030	1340452	1362125
1330096	1340701	1362200
1330097	1340751	1362250
1330101	1341007	1385000
1330120	1341050	1385101
1330140	1341052	1385102
1330160	1341101	1385103
1330161	1341125	1385104
1330180	1342001	1385301
1330200	1342002	1385302
1340040	1342003	1385501
1340051	1342101	1385701
1340060	1342125	
1340080	1342200	

* Additional model numbers may appear on the next printing of these instructions.

* Add 'C' to the end of the number for CSA approved models.

The labels on pages three and four must be securely attached to the lanyard and must be fully legible.

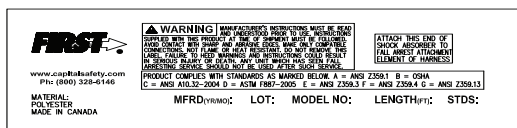

Labels 'A' and 'B' are for ANSI models only

